

AUTO

2020

MOBILITY, GEOGRAPHY, GENERATIONS

THE AUTOMOTIVE DIVIDE

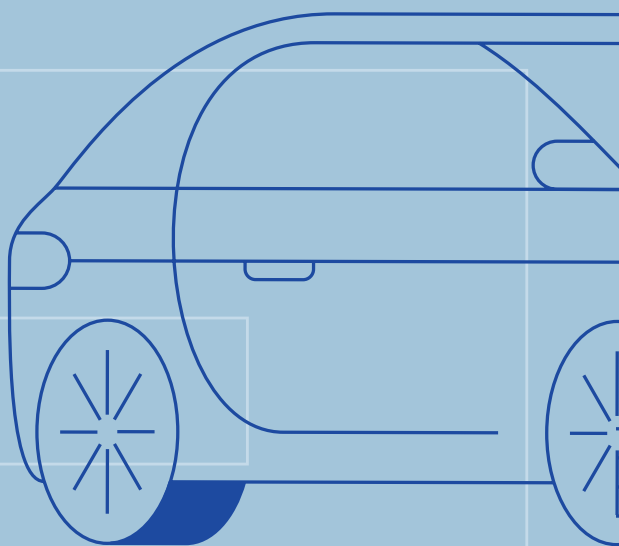

OBSERVATOIRE
Cetelem



EDITORIAL

THE AUTOMOTIVE DIVIDE

The automotive industry faces considerable challenges: technological, environmental, and social. Regulations are constantly evolving and rules vary from one continent to another.

This makes the task of manufacturers considerably more complex. But that's not all. The 2020 edition of L'Observatoire Cetelem shows that the role and uses of cars can differ depending on whether you live in an urban centre or in a rural area, but also according to your age and country of residence.

What we are seeing is a real schism in the automotive sphere. Two groups whose daily reality is very different and who do not always understand each other.

On the one hand, there are those for whom the car is simply a vital mode of transport that allows them to live their lives, while on the other, there are those for whom the car is a source of noise, pollution and urban congestion.

One side believes we should be fighting against the use of cars, the other that motorists should be protected by limiting the costs they incur. Is this an equation that cannot be solved? Not necessarily, but the schisms currently taking place will not be without repercussions.

The question is whether governments will allow manufacturers the time they need to adapt to new standards. They will also need to adapt their offerings to each continent. In Europe, the targets set for reducing CO₂ emissions will make the use of electric vehicles unavoidable. Automakers will have to sell a large number of them to avoid significant fines.

However, the United States, the world's second largest market, has chosen a different path and large 4x4s still have a bright future there. But will it be possible for manufacturers to invest billions in electric cars while also continuing to invest in internal combustion engines? Nothing could be less certain, with the recent withdrawal of some American manufacturers from the European market appearing to confirm this hypothesis.

Beyond this widening regulatory gap between continents, whatever their target markets manufacturers will have to meet the needs and expectations of motorists, which can vary a great deal, as our latest study shows.

Happy reading!

Flavien Neuvy
Head of L'Observatoire Cetelem

METHODOLOGY

Our economic and marketing analyses, as well as our forecasts, were conducted in partnership with **C-Ways** (www.c-ways.com), a survey and consulting firm that specialises in Anticipation Marketing.

The **quantitative** consumer interviews were conducted by **Harris Interactive** between August 30th and September 20th 2019 in **15 countries**: Belgium, Brazil, China, France, Germany, Italy, Japan, the Netherlands, Poland, Portugal, South Africa, Spain, Turkey, the United Kingdom and the United States.

In total, **10,000 individuals** were interviewed online (CAWI method). These individuals, aged 18 to 65, were drawn from national samples representative of each country. The quota method was employed to ensure that the sample was representative (gender, age). 3,000 interviews were conducted in France and 500 in each of the other countries.

Country codes: Belgium (BE), Brazil (BR), China (CN), France (FR), Germany (DE), Italy (IT), Japan (JP), Netherlands (NL), Poland (PL), Portugal (PT), South Africa (ZA), Spain (ES), United Kingdom (UK), United States (US), Turkey (TR).

Co-authored by: Luc Charbonnier and C-Ways
Editorial Coordination: Patricia Bosc
Design: © Insign.

TABLE OF CONTENTS

1. I (STILL) LOVE MY CAR.....	7	3. NEW MOBILITY SOLUTIONS THAT ARE YET TO PROVE THEIR WORTH.....	43
An enduring love	8	Reinventing motoring through services.....	44
Owning a car: reasons and feelings	12	Ride sharing: a financial imperative	48
Public transport: the alternative favoured by young people and urbanites	16	Rejecting ride sharing: money isn't everything	50
A seriously ideal car	18	Car sharing: the advantages remain to be confirmed....	54
Giving up on owning a car	20	The car: still a protected space	60
2. A SHADOW OF A DOUBT	25	4. THERE ARE SOLUTIONS FOR THE FUTURE, BUT SCHISMS PERSIST	67
Protecting the environment: rising awareness and condemnation	26	Cars still have a bright future	68
A budgeting issue first and foremost.....	32	The future of motoring is on track	72
Driving less to spend less	38	Indicators that point to schisms in the automotive world.....	74
		Young people and urbanites take the lead	76
		KEY FIGURES.....	80
		COUNTRY FACT SHEETS	87

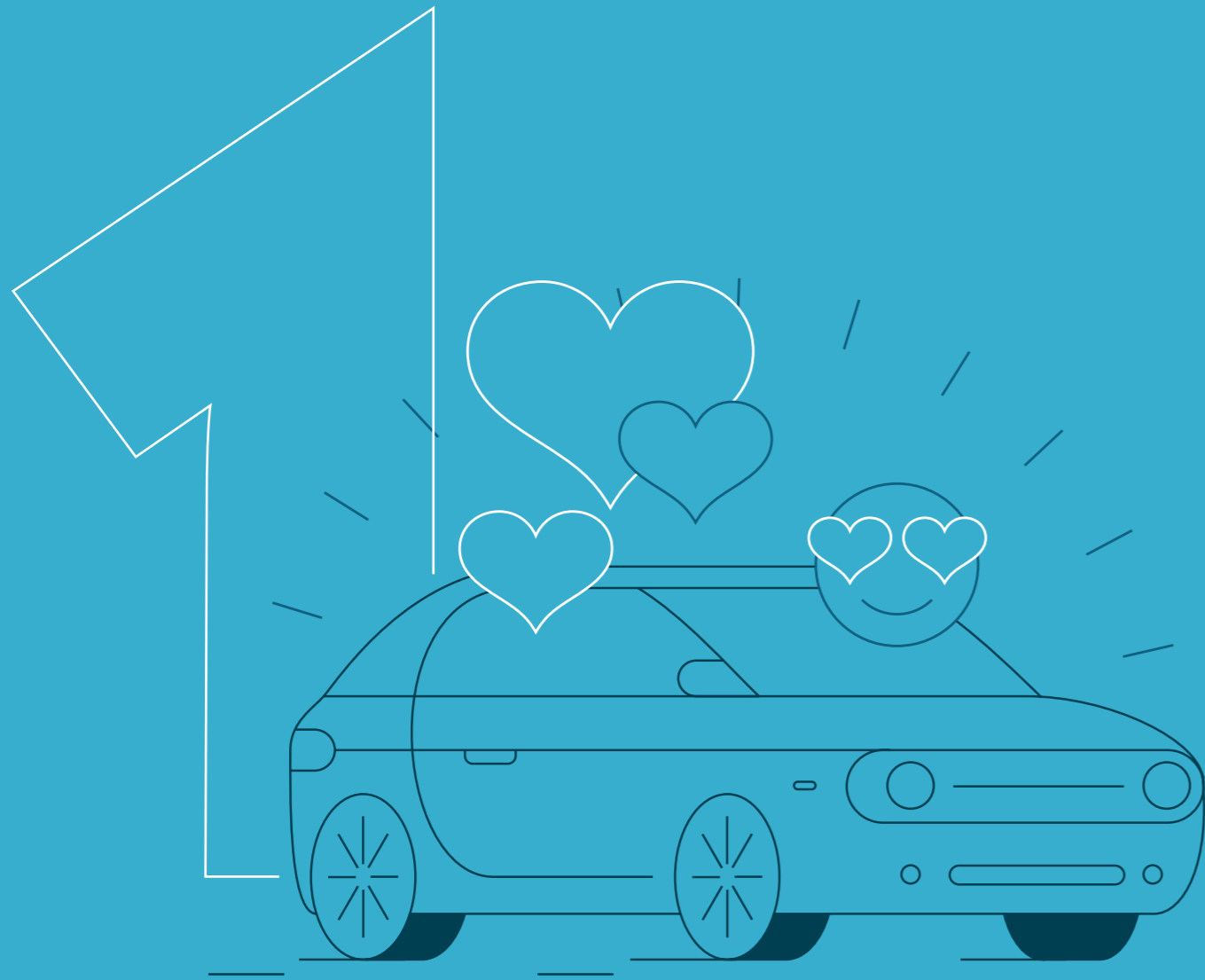

I (STILL) LOVE MY CAR

If there is one area where love seems eternal, it is the automotive sector. Economic crises, mistrust, constraints, changing lifestyles and behaviours, nothing seems able to alter the role and uses of this century-old star product, and it remains in rude health. But the love motorists have for their vehicle is far from blind, and their feelings are rooted in reason.

AN ENDURING LOVE

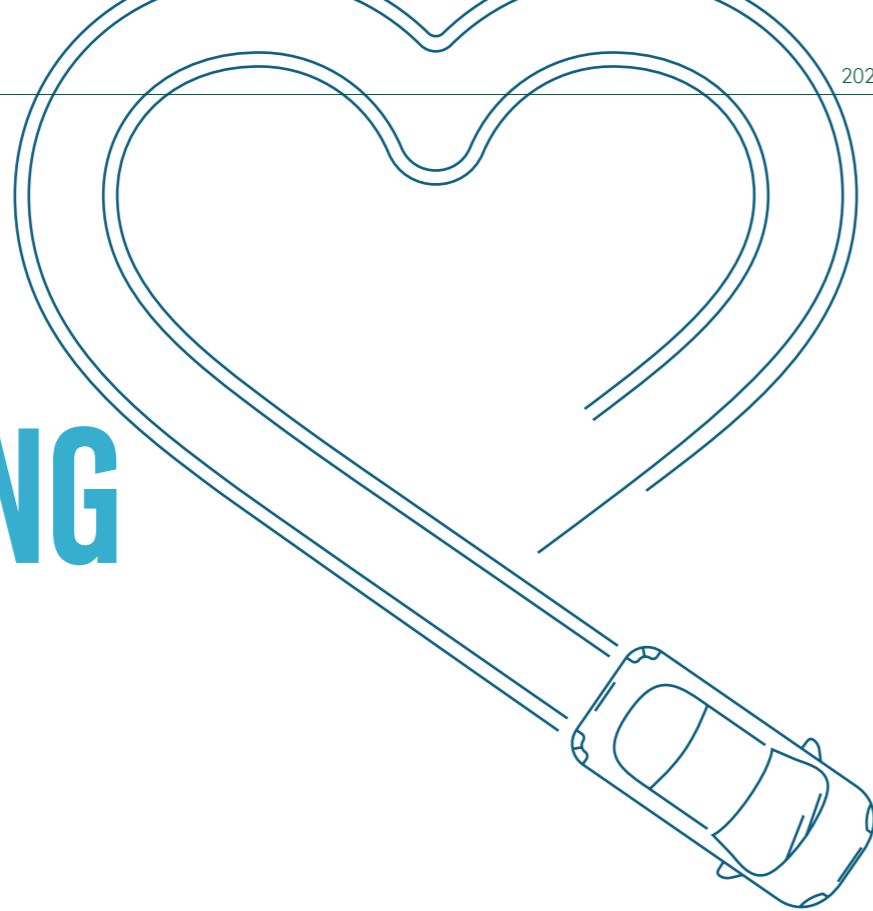

A major manufactured product and a symbol of the development of consumerism, the car receives as much praise from enamoured admirers as it does condemnation from its fierce opponents. Because if any fact has been firmly established since Joseph Cugnot built the first motor vehicle in 1769, it is that the automobile leaves nobody indifferent. 2017's L'Observatoire Cetelem, entitled "I love my car", highlighted the fact that 9 out of 10 motorists had a positive or very positive view of cars. 8 out of 10 considered that they simply could not do without them.

AN UNWAVERING ENTHUSIASM

Three years on, the car is almost equally as popular. 8 out of 10 people say they are attached to the vehicle they own (Fig.1). Italy, Poland and Spain are the most enthusiastic (9/10), while Belgium and China are less unanimous (7/10). France posts a result that is close to the average, while the United States, where the car is king, displays a little less fervour.

THE RISING MOTORIZATION RATE: AN EXPRESSION OF LOVE

If proof of the popularity of cars were needed, motorization rates (Fig. 2 and 3) would be among the clearest pieces of evidence. In recent years, these figures have grown

continuously in the countries of L'Observatoire Cetelem, with two notable caveats. Large urban centres in the Western world have experienced a decline. China, where sales are currently falling, continues to see an increase in its motorization rate. However, it still posts the lowest score in this ranking, closely followed by South Africa, Turkey and Brazil. These nations, where motorization rates are lower and have started to take off only recently, form a quartet whose behaviour is homogeneous and contrasts with that of other countries. This unusual quartet illustrate the geographical divide that affects certain aspects of the global automotive sector. And it is no surprise that the United States tops the list when it comes to the number of cars per inhabitant.

Fig. 1

Are you attached to your car?

In %, sum of "Yes" answers (Very/Somewhat)
Question asked only to car owners

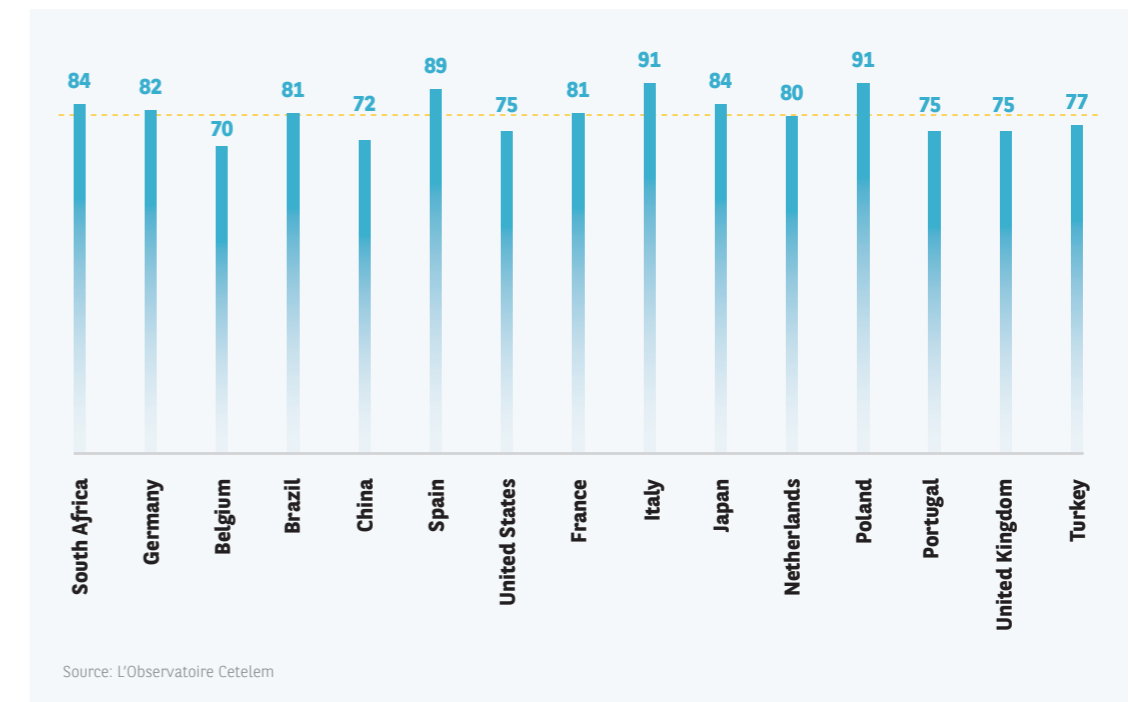

Source: L'Observatoire Cetelem

Fig. 2

Motorization rate in 2017

Number of vehicles per 1,000 inhabitants

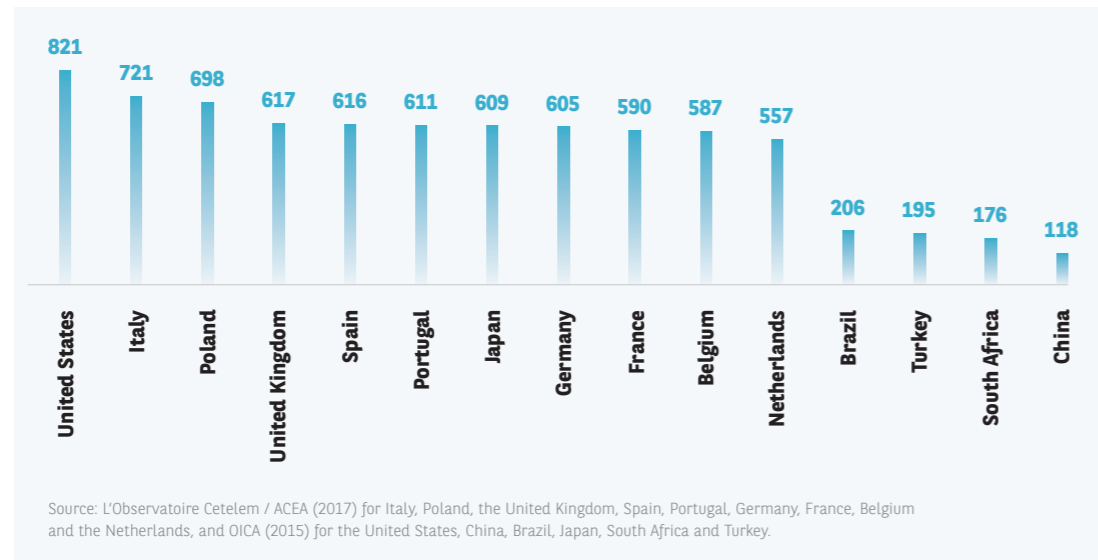
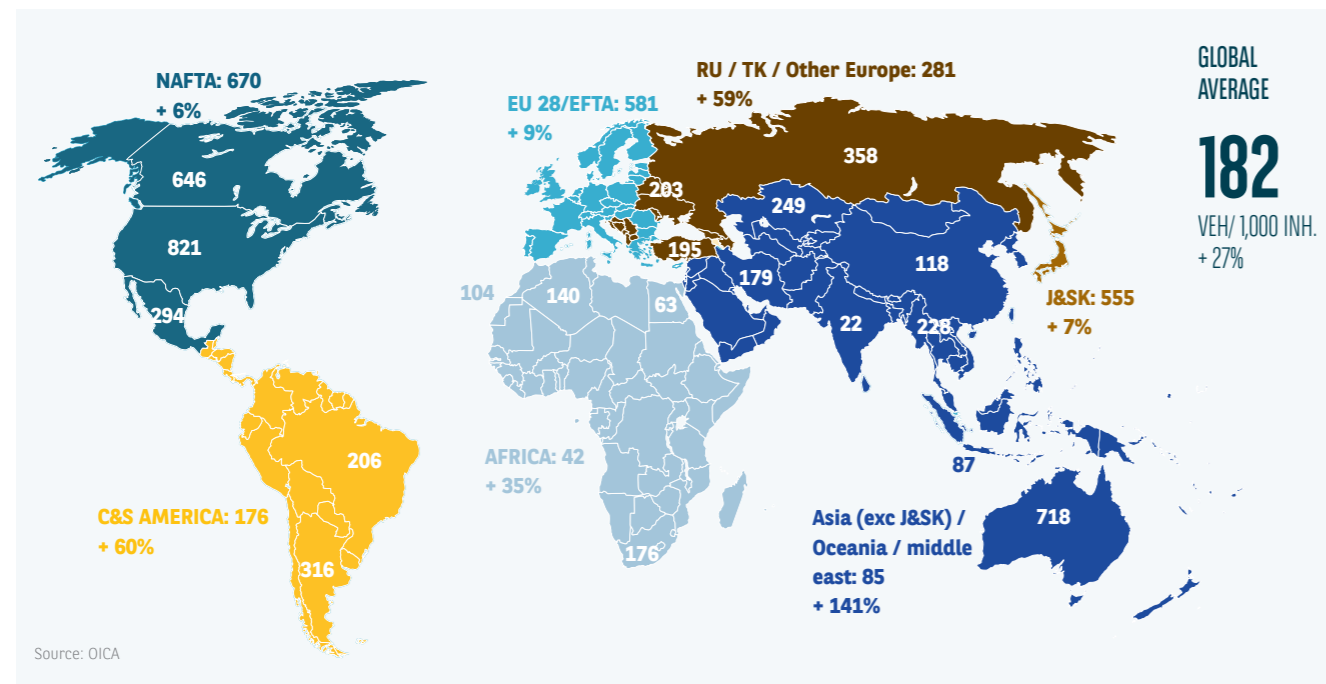

Fig. 3

Variation in the motorization rate between 2005 and 2015



POPULARITY AMONG THE YOUNG

Another piece of good news for manufacturers is the fact that millennials, i.e., their future customers, are more inclined than their elders to declare their attachment (Fig. 4). This generational difference is certainly the most significant divide highlighted by the survey. In China, millennials are actually more than twice as likely as seniors to voice such attachment. This is in great part down to the breathtaking growth of the automotive sector in recent times. Cars have always been a part of young people's lives.

This is not the case for seniors, who lived without cars for many years. Moreover, because millennials are naturally more likely to live in cities, people's fondness for cars is greatest in conurbations with more than 1 million inhabitants. This new schism has led to "city cars" and "rural cars" being perceived differently. The gap is particularly wide in China, the United States and Japan, which are home to a number of megacities.

Fig. 4

Are you attached to your car?

In %, sum of "Yes" answers (Very/Somewhat)

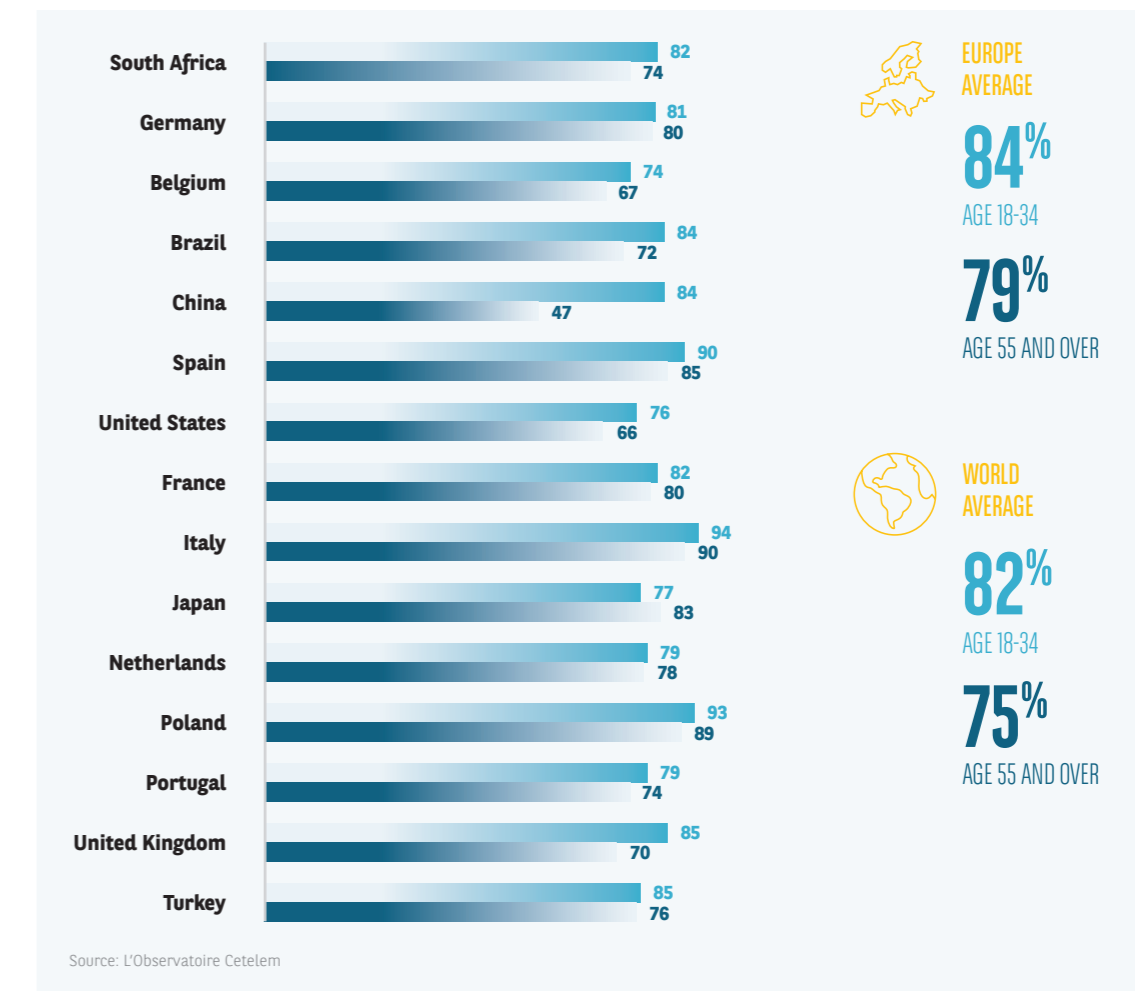

OWNING A CAR: REASONS AND FEELINGS

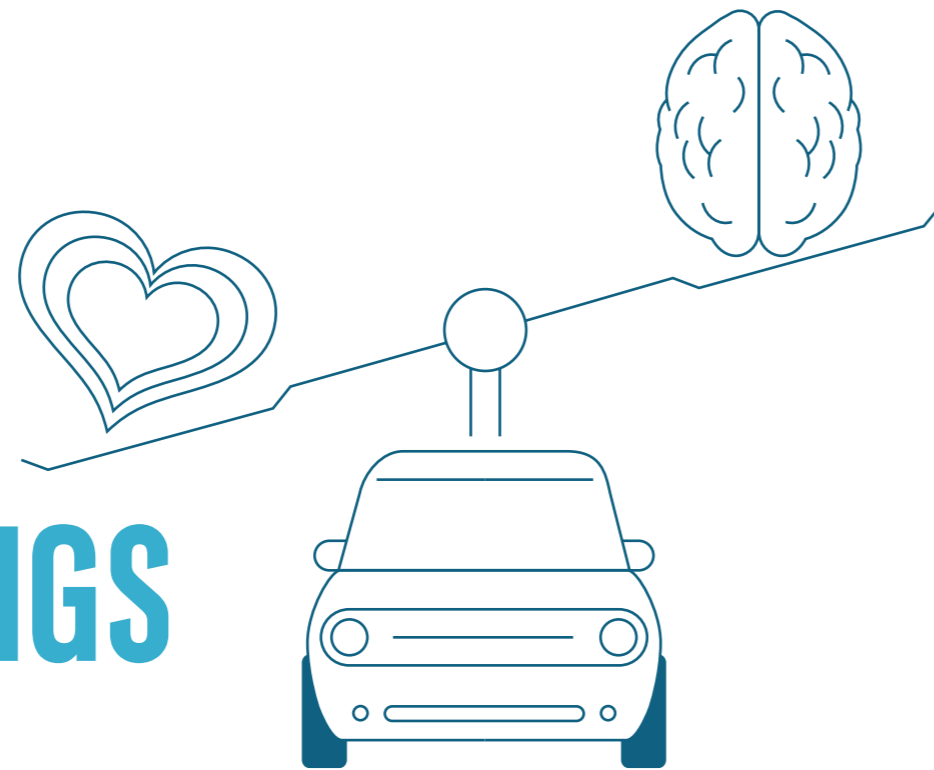

Beyond this “love” of cars, various reasons, based on a mixture of pragmatism and idealism, prompt people to acquire a vehicle (Fig. 5 and 6). 39% of those interviewed, believe that a car is, above all else a vital form of transport, a view most likely to be expressed by those in rural areas (47%) and seniors (44%). This is most clearly stated in Italy, Belgium and Japan, but much less in Germany. But the car is not only a practical item, because it continues to be a vessel for people’s dreams. For 17% of motorists, it is an incomparable path to freedom. This is an opinion shared by all generations, particularly in Spain and Germany (40% and 31%). Conversely, only 5% of Japanese respondents associate cars with freedom.

12% believe that driving is a pleasure in itself, a feeling that is strongest among the Americans and South Africans (22%). Only 5% of Portuguese respondents cannot see the pleasure in driving. On this point, millennials seem to be anticipating or only just discovering the potential pleasure that cars can bring and are more enthusiastic than their elders, for whom driving seems to have lost its lustre over the years (15% vs. 9%).

Lastly, 11% consider cars to be a financial constraint. 9% believe that their usefulness is waning, given the expanding range of transport options (public transport, car sharing, ride sharing, etc.).

Fig. 5

Above all, you see owning a car today as being...
In %, only one possible answer

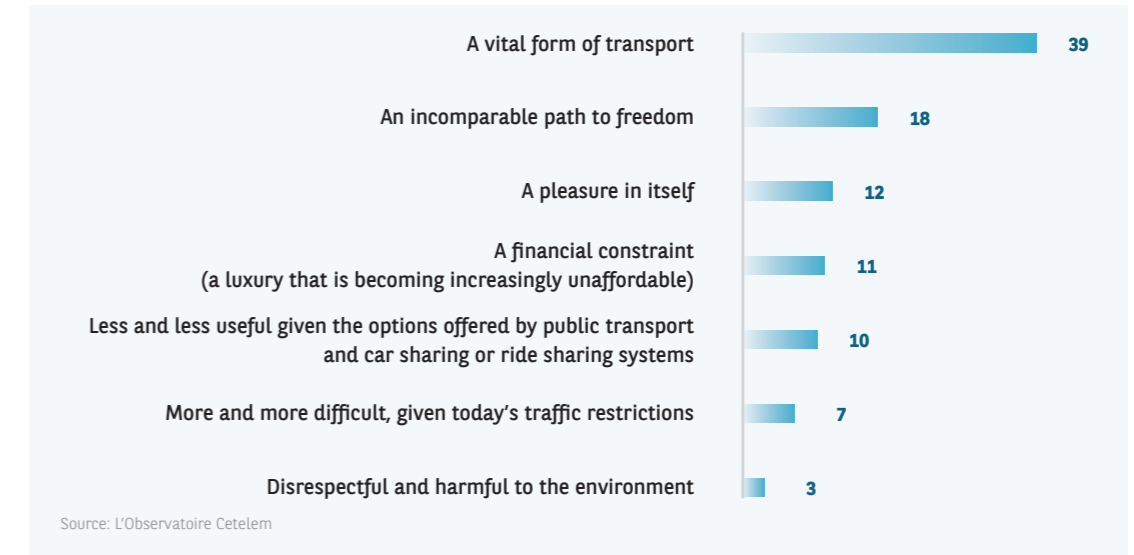
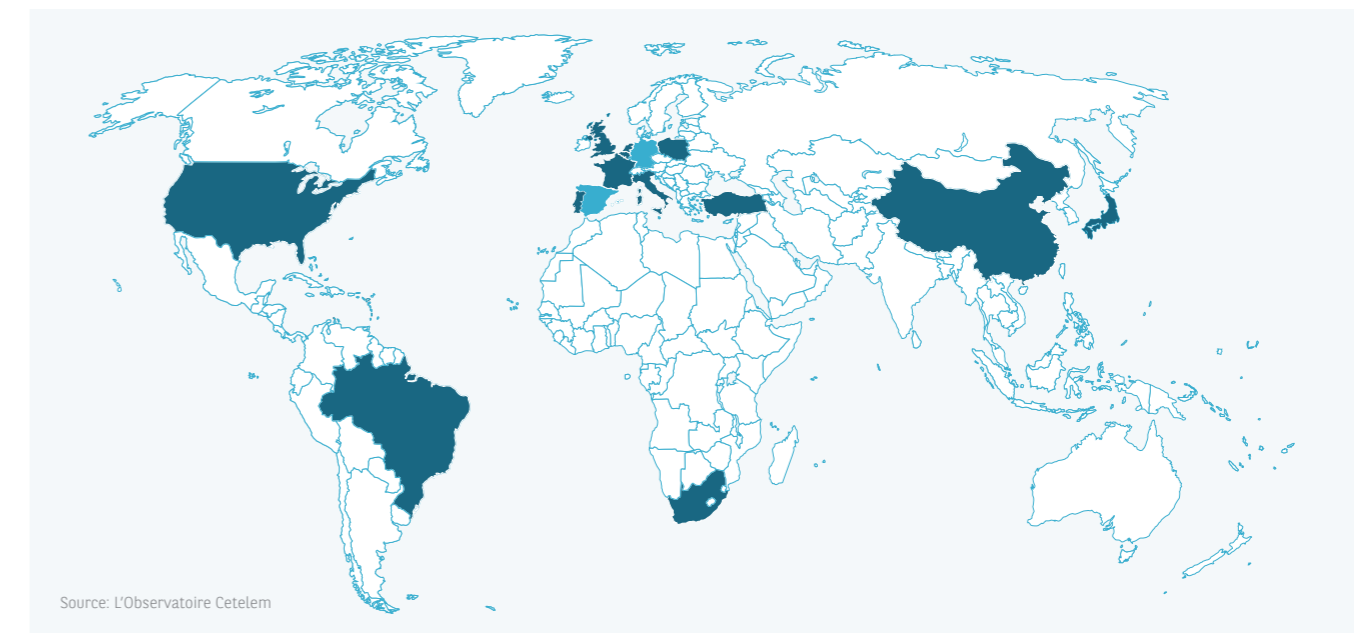

Fig. 6

Above all, you see owning a car today as being...
The colours represent the majority opinion in each country



● A vital form of transport

● An incomparable path to freedom

**KEEPING ONE'S CAR:
A PRIMARILY EMOTIONAL CHOICE**

When it comes to expressing their reasons for keeping their vehicle, motorists put forward a vision that is more idealistic than pragmatic (Fig. 7 and 8). 59% of respondents view the freedom it gives them as being decisive. The South Africans, Portuguese and Germans place the greatest focus on freedom (74%, 69% and 66%), while the Japanese and Chinese are at the other end of the scale (44% and 52%). The French post a close-to-average score.

38% simply state that they love their car. The majority of South Africans also declare their love for their vehicle (60%), much like the Americans and British, who are true to their reputation as car enthusiasts (57% and 52%). However, contrary to the stereotype, the Italians are the least fond of their cars (22%). 23% cannot imagine living without a car. The South Africans are once again the most likely to reject this prospect (35%). Meanwhile, the Chinese, who live in the world's largest automotive market, and the Italians fear this idea the least (12% and 14%).

Fig. 7 Why aren't you ready to part with your car?
In %, several possible answers

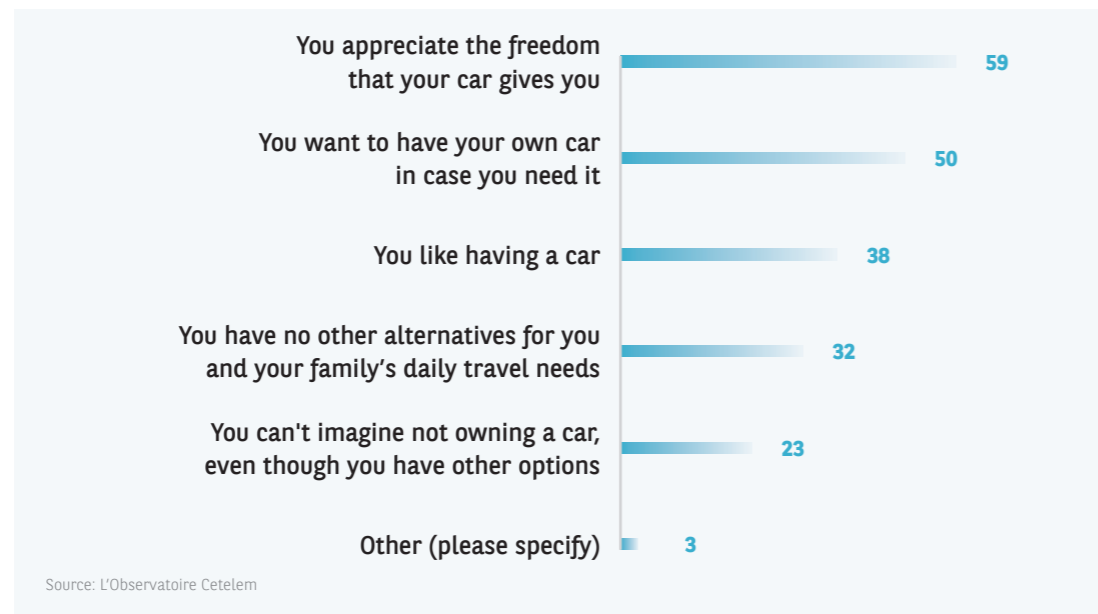

KEEPING A LEVEL HEAD (AND YOUR CAR)

There are other more sensible reasons why motorists do not want to let go of their car. 50% of respondents believe that there are eventualities in which a car could be essential. This is very much the view in China (61%), but much less so in Turkey (26%). 32% consider that they have no other travel alternatives, with the French being the most likely to state this opinion (44%).

This result goes some way to explaining why debating car use in France can be a potentially explosive endeavour (as demonstrated by the "yellow-vest" movement). Conversely, despite living in a vast country, just 15% of Brazilian respondents deem that cars have no credible competition.

Fig. 8 Why aren't you prepared to part with your car?
The colours represent the majority opinion in each country

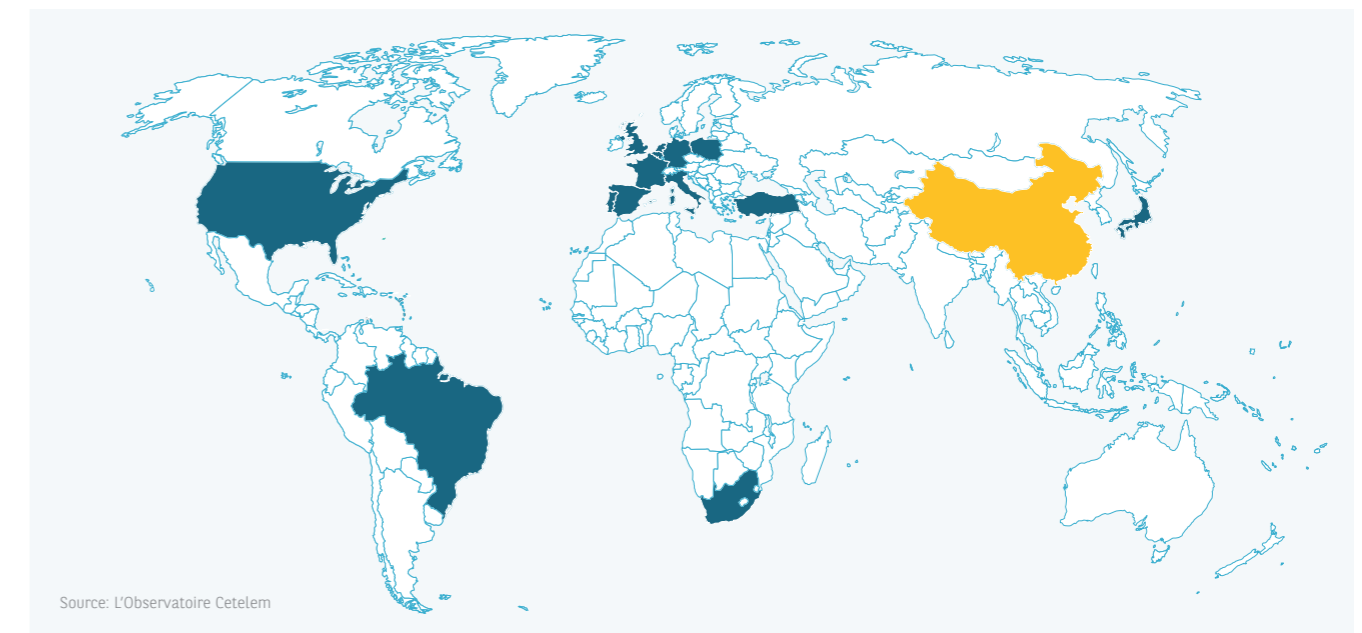

- You appreciate the freedom your car gives you
- You want to have your own car in case you need it

PUBLIC TRANSPORT: THE ALTERNATIVE FAVOURED BY YOUNG PEOPLE AND URBANITES

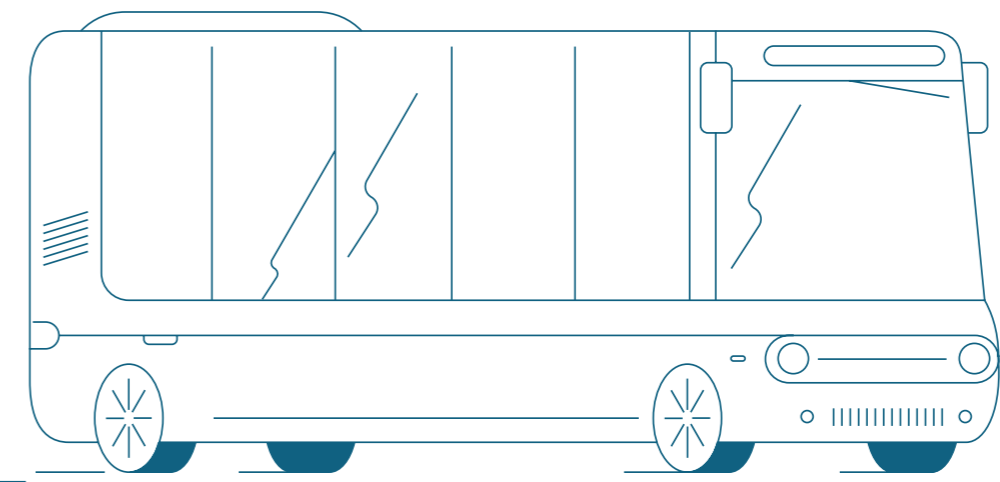
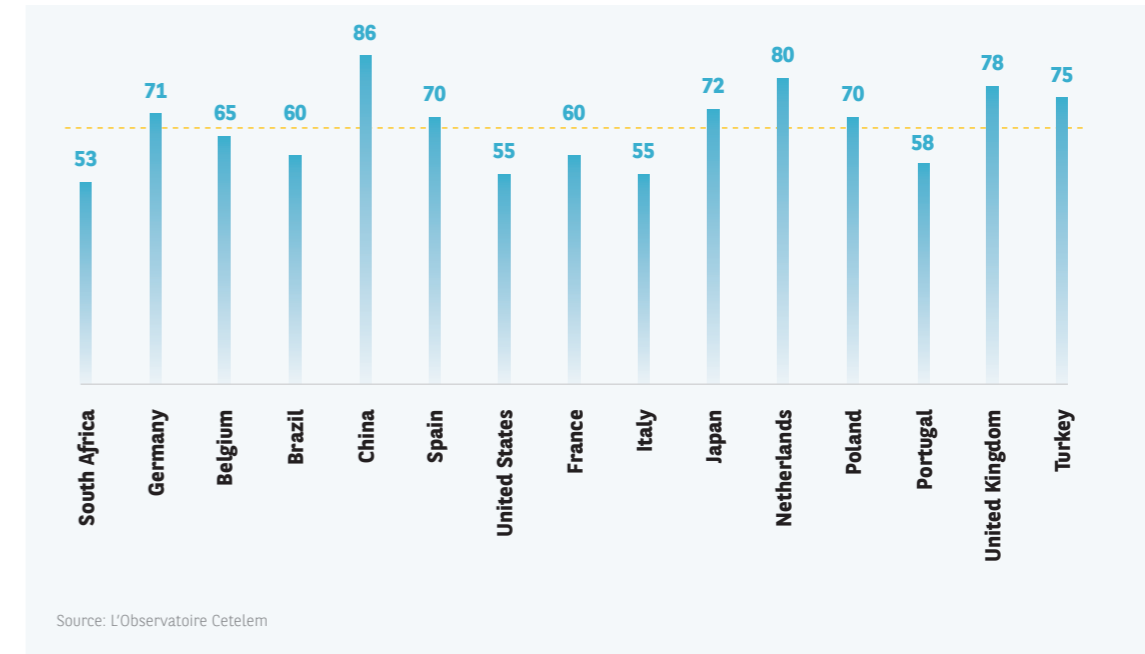

Fig. 9

Do you believe that your local public transport network is...
 % who answered "Developed" (Very/Quite) one possible answer

67%
 EUROPE AVERAGE

67%
 WORLD AVERAGE



For many, the ability to choose an alternative to car travel depends on the availability of public transport (Fig. 9). Two-thirds of respondents believe that the public transport network around their home is sufficiently developed, with the Chinese, Dutch and British being the most likely to agree (86%, 80% and 78%). This satisfaction with the public transport system is felt most keenly by urbanites and certain generations. In major cities, the results are

almost unanimous, which is the case in Poland (100%), Germany, China and Japan (96%, 96% and 95%). 92% of French city dwellers also rate their public transport networks highly. Millennials, apart from those in Turkey, are generally pleased about their level of development. In relative terms, young South Africans display by far the highest level of enthusiasm: 65%, compared with just 12% of seniors.

A SERIOUSLY IDEAL CAR

So yes, we love our cars. They embody values such as freedom and we are very attached to them. And yes, the ideal car does exist. Only 8% of the people interviewed believe the opposite. And yet, this ideal car's strengths could not be more prosaic.

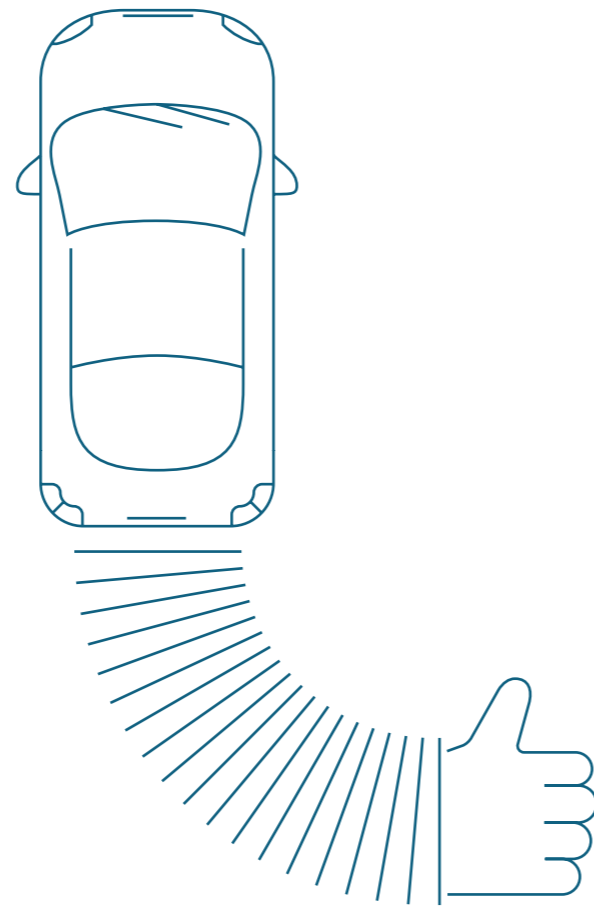

SOLID QUALITIES

A car is seen as ideal (Fig. 10), first and foremost, if it keep its occupants safe (42%), a feature deemed important by the majority of Spanish, South African and Japanese respondents. The ideal car should also be comfortable (34%). Here again, the Japanese are the most sensitive to this factor, followed by the Brazilians. Only 10% of Germans point to this feature, no doubt because they see German saloon cars as being inherently comfortable.

The next three features in the ranking generate roughly identical opinions. Just over a quarter of respondents believe that the ideal car should be durable, cost as little as possible

to buy and use, and be pleasant to drive. It is worth noting that these features are particularly important to seniors and country dwellers.

ENVIRONMENTALLY FRIENDLY, YES, BUT...

26% also state that a car should have a low environmental footprint. Americans and Brazilians are the least likely to highlight this feature, reflecting the lack of regard for the environment shown by their respective current leaders. But given that 3% of respondents believe that owning a vehicle is disrespectful and harmful to the environment, we might conclude that motorists consider that cars themselves must be eco-friendly, rather than their owners.

NEITHER A STATUS SYMBOL NOR THE EMBODIMENT OF A VISION

At the bottom of the list of criteria that define the ideal car, the idea that it should be a symbol of one's status is put forward by just 5% of respondents. This figure further highlights an irreversible shift that was already apparent in many previous L'Observatoire Cetelem surveys, including "I love my car". Millennials, urban dwellers,

the Chinese and the Japanese are a little more eager than average to enhance their image thanks to their car. Finally, it appears that the ideal car is far from being associated with a triumphant modernity, both in its perception and in its use. 8% see it as being ultra-high-tech and 7% imagine it as a pay-as-you-go service, for which one is only charged when it is used.

Fig. 10

In your opinion, the ideal car is...

Up to four possible answers

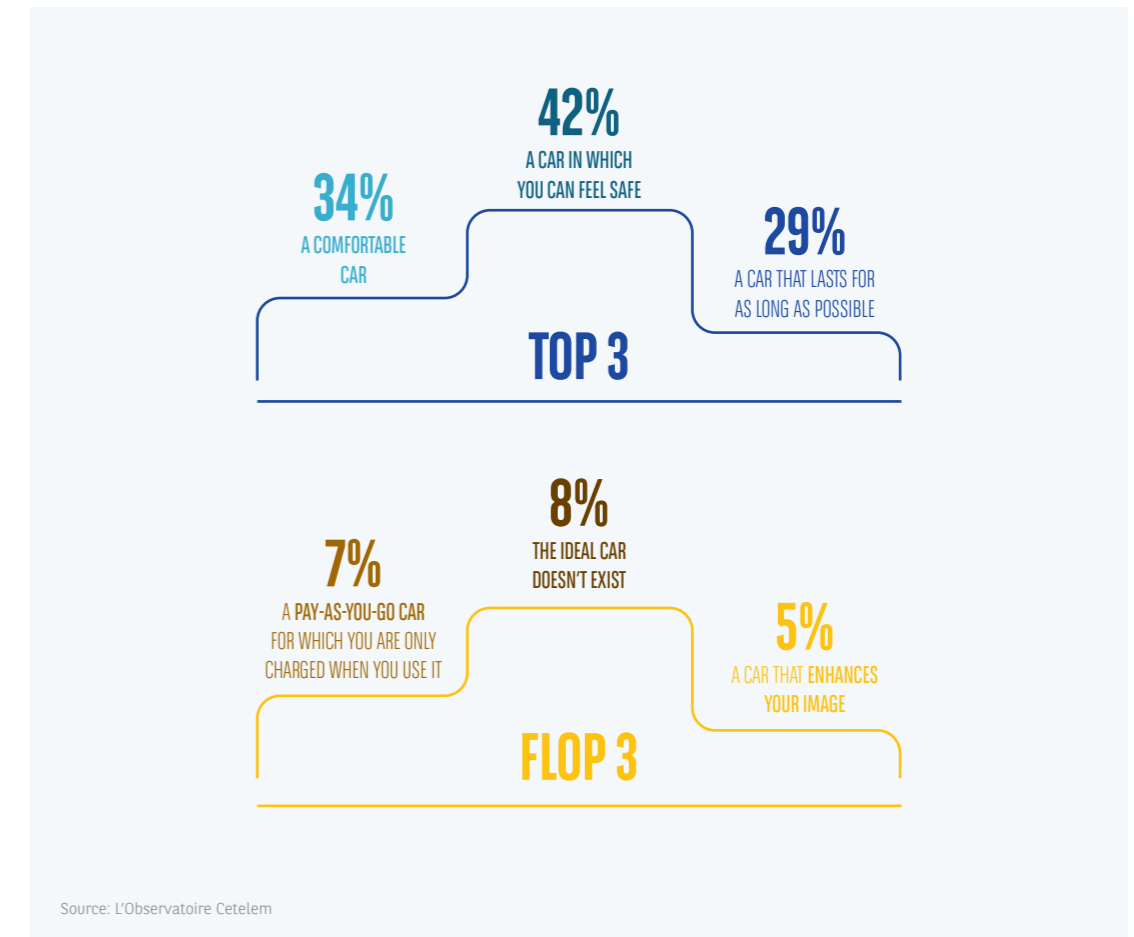

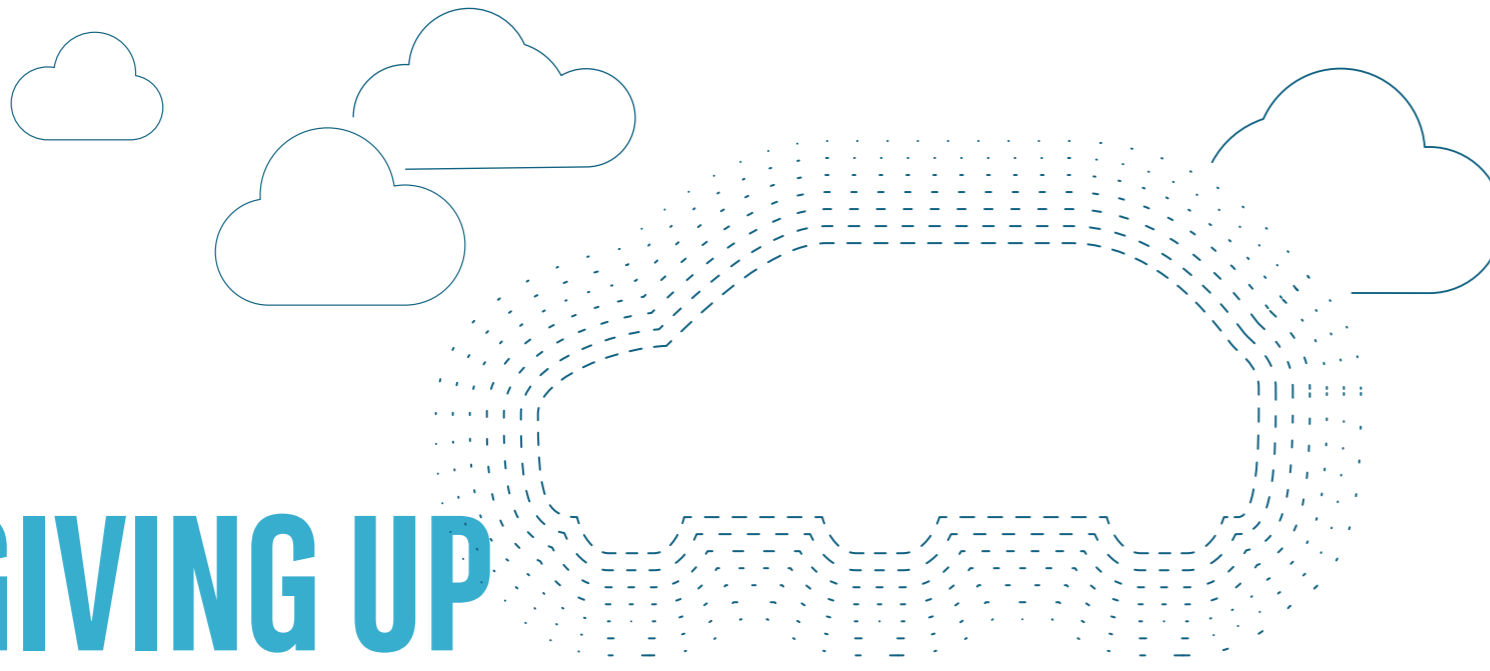

GIVING UP ON OWNING A CAR

But while the ideal car does appear to exist in the eyes of motorists, they no longer feel it is essential to own one, at least in certain circumstances (Fig. 11 and 12). 6 out of 10 respondents hold this view. 8 out of 10 Chinese are of this opinion. Conversely, the French are the least likely to look forward to a car-free future (43%).

Millennials are the least averse to considering living without a car, although there are differences between the countries. The majority of urbanites take this view. This radical position is founded on a paradigm shift that is both ecological and economic, one that is set to trigger major schisms.

Fig. 11 and 12

Can you imagine never (or no longer) owning a car?

In %, sum of "Yes" answers (Absolutely/In some circumstances)

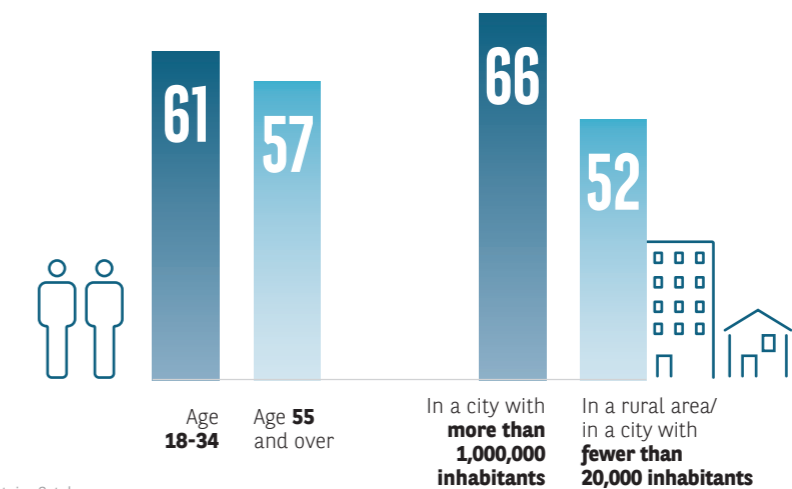
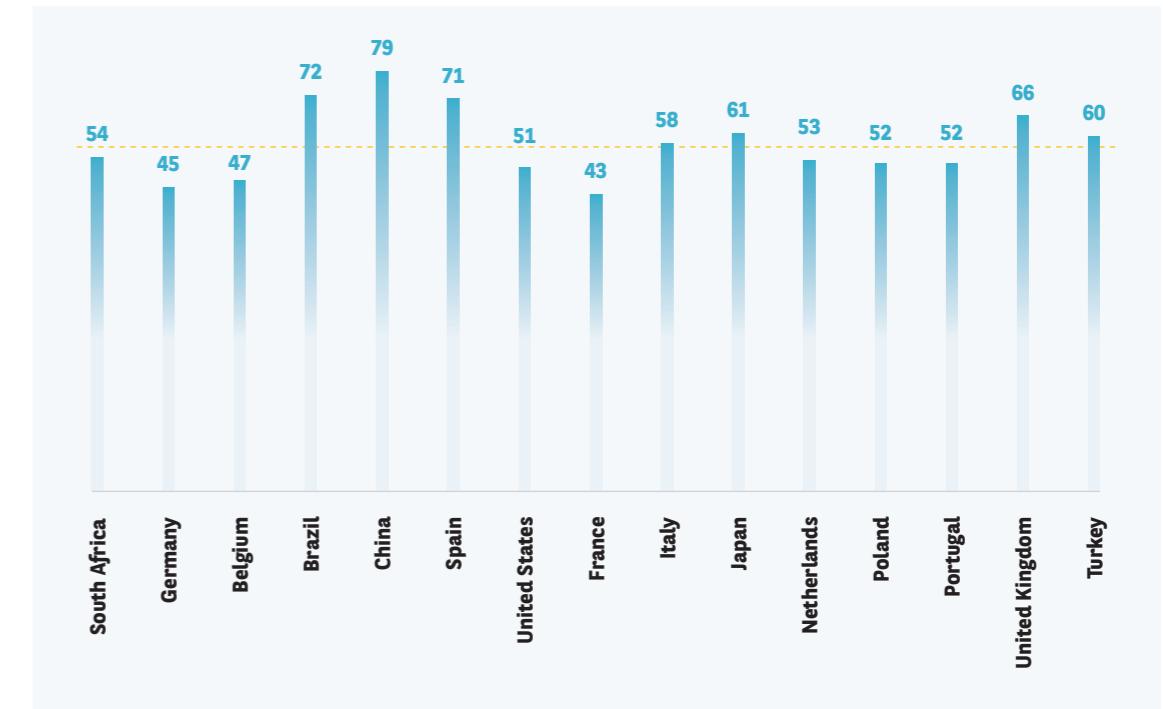

Source: L'Observatoire Cetelem

Mileages are no longer falling

Having dropped steadily between 2000 and 2012, the distance travelled per car seems to have stabilized in many countries. It is even on the rise again in some (Spain, Austria, France). And while this increase in distances is due in part to lower fuel costs, it is nonetheless fresh evidence that cars remain essential, even if people are not prepared to own one at all costs.

AVERAGE DISTANCE TRAVELLED PER CAR (INDEX 100 IN 2000)

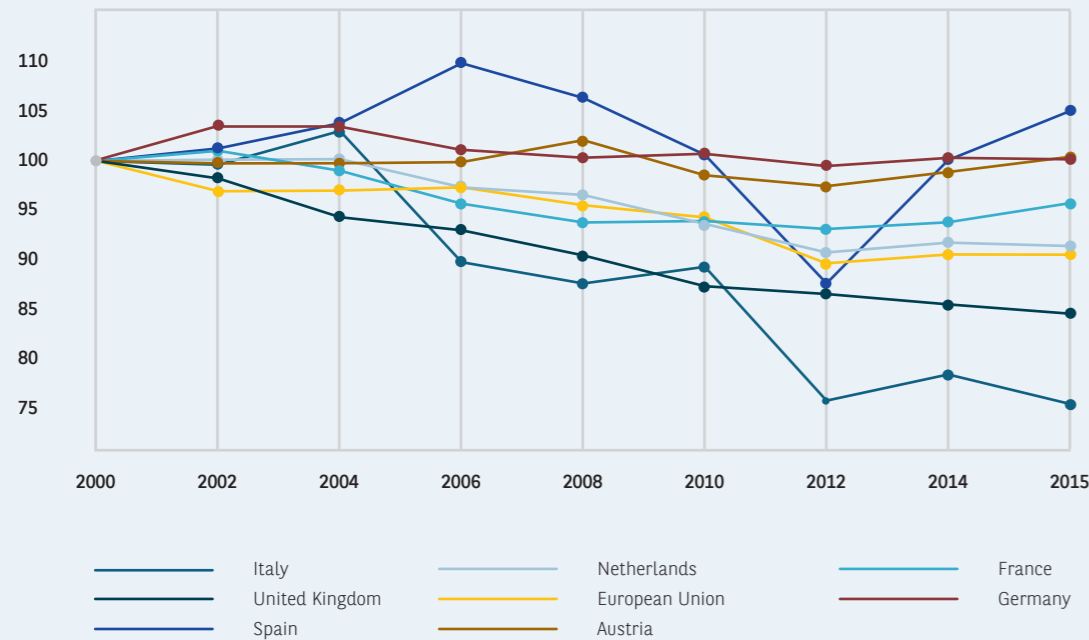

Source: Enerdata

SUMMING UP

KEY FIGURES



8 out of 10 people are attached to their car.



4 out of 10 believe that cars are an essential form of transport, first and foremost.



6 out of 10 want to keep their car because of the freedom it gives them.



9 out of 10 believe that the ideal car exists.



6 out of 10 are prepared to do without a car.

SCHISMS

- Millennials and urban dwellers are more attached to their car than their elders.
- In terms of motorization rates, a geographical divide remains between the "emerging" countries and the other countries surveyed.
- Cars are essentially "practical" in the eyes of seniors and rural people, and synonymous with "pleasure" according to millennials.
- Public transport is a serious competitor for cars in the opinion of young people and urbanites.

A SHADOW OF A DOUBT

Behind the general feeling that cars are well loved and that motorists are very attached to them, there are both generational and geographical divides that temper this idealized image. Economic and environmental concerns generate polarization between millennials and seniors, urbanites and rural dwellers, and between inhabitants of developed economies and emerging nations.

PROTECTING THE ENVIRONMENT: RISING AWARENESS AND CONDEMNATION

In the space of just a few years, environmental concerns have become an issue for everyone, not just those in the scientific sphere. The automotive sector cannot escape this reality, which has brought about very tangible changes.

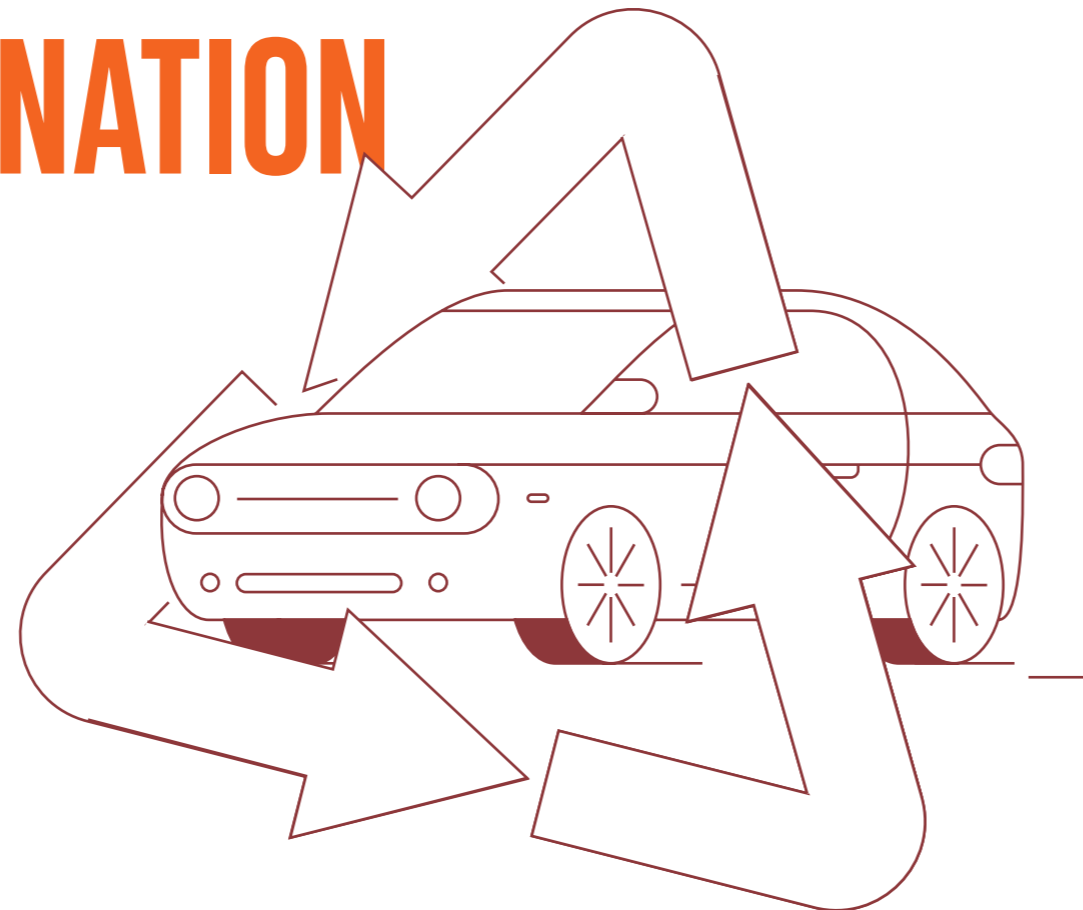

A CHANGE IN ATTITUDES

Three-quarters of respondents are concerned about the environment and say that they have changed their consumption habits accordingly (Fig. 13 and 14). The Italians, Spaniards and Turks display the most concern, while the Japanese, despite having experienced various natural disasters, are the least likely to do so (44%).

While American millennials are more engaged than their elders and Chinese city dwellers more so than their rural compatriots, the differences within each country are, on the whole, not significant. The urban/rural divide is the widest, with city dwellers tending to be more mindful of making eco-friendly consumption choices.

Fig. 13 and 14

I am very mindful of environmental issues and am altering my consumption habits to make them greener

In %, sum of "Yes" answers (Very / Somewhat)

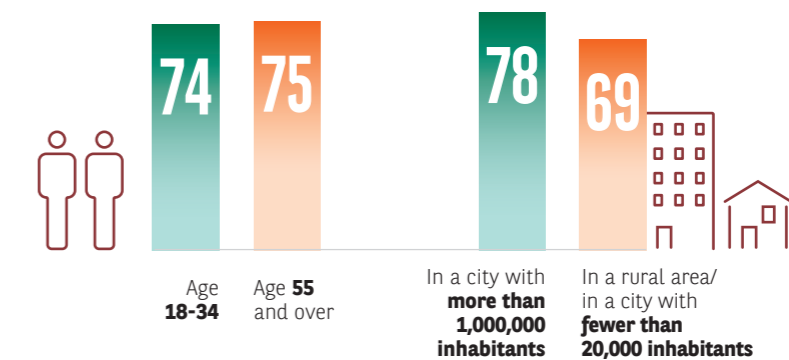
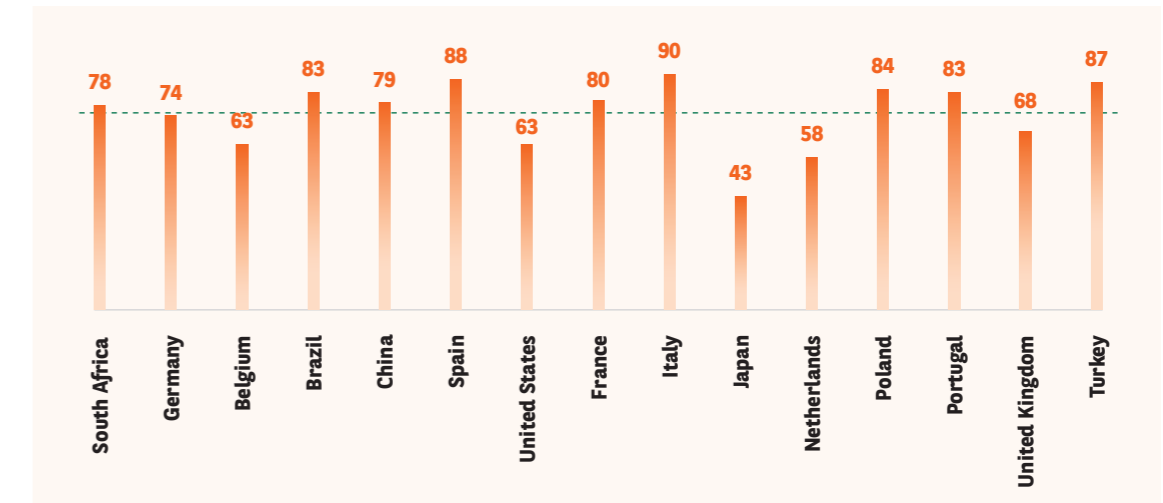

Source: L'Observatoire Cetelem

YOUNG PEOPLE AND URBANITES POINT THE FINGER

This newly formed environmental awareness is now leading even motorists to point to cars as being the main culprits. 66% of those surveyed consider them to be the number one source of pollution (Fig. 15 and 16). This widespread condemnation masks clear geographical, generational and residential divides. Turkey, China, South Africa and Brazil are unreserved in their criticism (89%, 83%, 77% and 74%). Inhabitants of the Iberian Peninsula hold equally clear-cut views. However, most of the developed economies are much less virulent (Germany 42%, France 46%, Belgium 47%, Netherlands 47%).

Vast generational differences are also apparent. Millennials in France are twice as likely as seniors to consider cars as the leading source of pollution (63% vs. 30%). In Germany, Belgium and the Netherlands, the proportion is almost identical. There are also significant differences in South Africa and the United Kingdom. Analysing these results according to where people live again shows that Germany, France, Belgium and the Netherlands harbour the greatest divides between inhabitants of large cities, who tend to be very critical of car pollution, and their much less condemnatory rural populations.

Fig. 15 and 16

In your opinion, are cars the main cause of pollution today?
In %, sum of "Strongly agree" and "Agree" answers

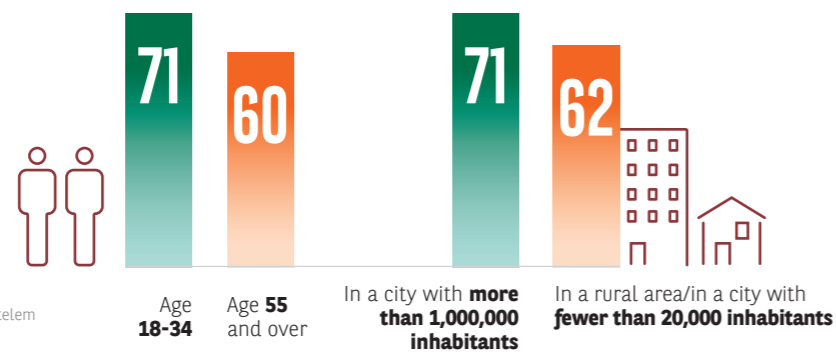
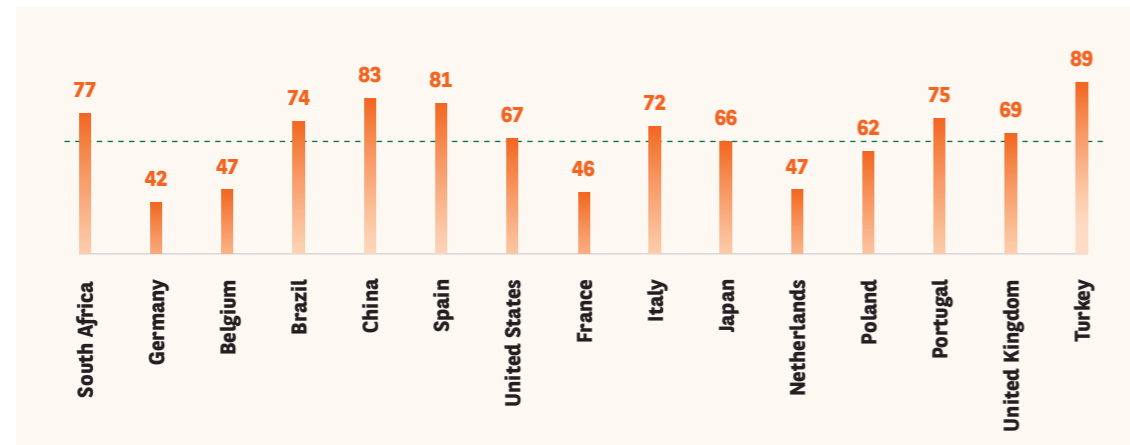

Source: L'Observatoire Cetelem

Measures that vary from country to country

While the climate issue seems to have taken hold in the media landscape and in the consciousness of citizens, government measures to reduce vehicle pollution vary significantly from one country to another in terms of their toughness.

NUMBER OF LOW-EMISSION ZONES IN EUROPEAN COUNTRIES (INDICATIVE FIGURES FROM NOVEMBER 2018)

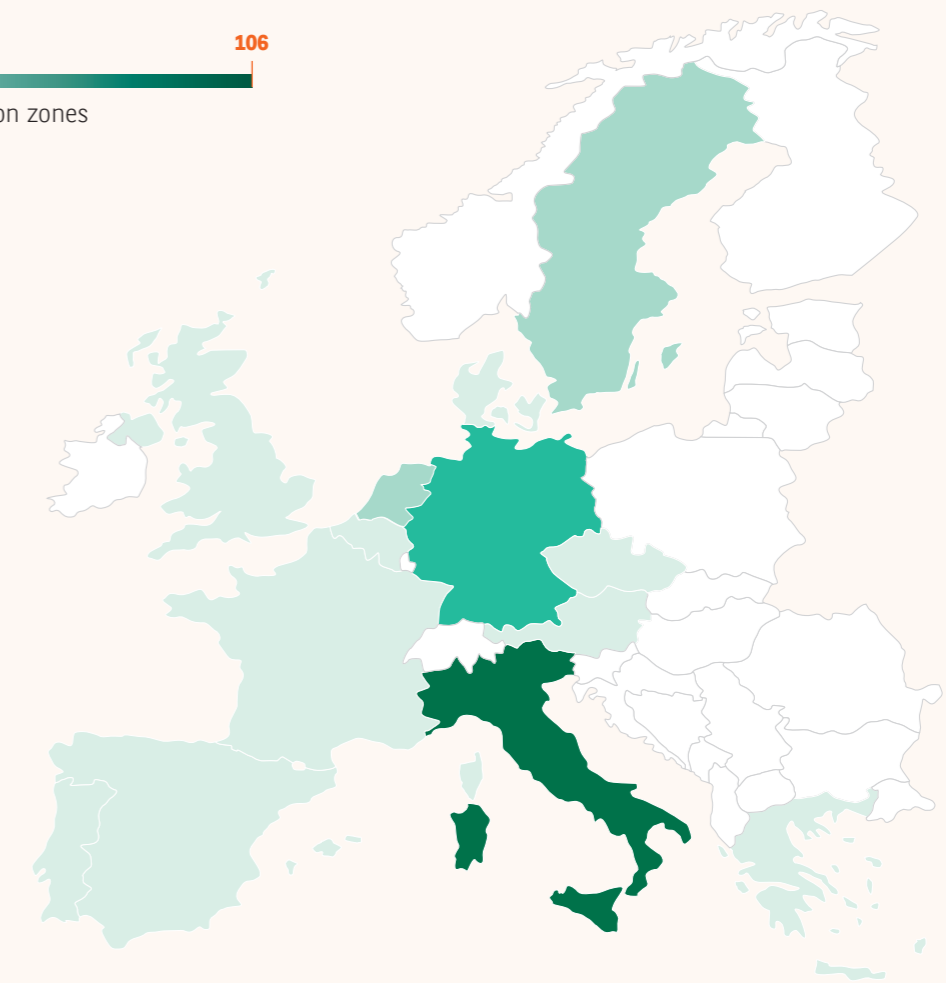
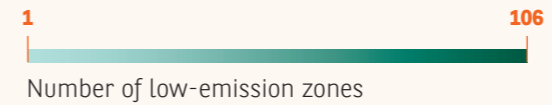

Source: ADEME, Report on low-emission zones in Europe
<https://www.ademe.fr/sites/default/files/assets/documents/rapport-zones-faibles-emissions-lez-europe-ademe-2018.pdf>

GROWTH IN THE NUMBER OF LOW-EMISSION ZONES

	March 2011	March 2012	March 2014	March 2015	September 2017	November 2018
Austria	1	1	2	4	4	4
Czech Republic	1	1	1	1	1	1
Denmark	4	4	4	4	4	4
Germany	43	56	69	78	83	86
Italy	109	98	94	100	108	106
Netherlands	12	12	12	13	13	13
Portugal	0	1	1	1	1	1
Sweden	6	6	7	8	8	8
United Kingdom	2	2	3	1	1	1
Greece	-	-	-	1	1	1
France	-	-	-	-	2	3
Belgium	-	-	-	-	1	2
Spain	-	-	-	-	-	1
TOTAL	179	182	193	211	337	231

Source: <https://www.ademe.fr/sites/default/files/assets/documents/rapport-zones-faibles-emissions-lez-europe-ademe-2018.pdf>
 ADEME, Report on low-emission zones in Europe

ENVIRONMENTALLY COMPATIBLE PURCHASE INTENTIONS

Car purchase intentions also reflect the behavioural changes currently taking place (Fig. 17 and 18). While those who intend to purchase a petrol vehicle are still in the majority (59%), a rapidly increasing number of people would prefer a hybrid or even an electric model (49% and 33%, respectively). As a consequence, the dominance of diesel now seems finally over (32%). The rise of hybrids (55%) and electric vehicles (39%) is particularly significant in urban areas. Ever-increasing travel constraints in metropolises, together with the rapid

rise in the availability of new options, as a result of recent environmental standards, go some way to explaining these figures, which should increase significantly in the coming years. Geographically speaking, "green purchasing" intentions are particularly strong in Japan, Italy, Spain and China, which favour hybrids (74%, 72%, 69% and 67% respectively). Again we see China, along with Portugal, Italy and Japan, very much considering the electric option (50%, 46%, 41% and 40%). Conversely, it is unsurprising to see the United States clinging to petrol engines (80%), while most Turks prefer diesel (59%).

Fig. 17 and 18

Do you intend to purchase...
 In %, several possible answers

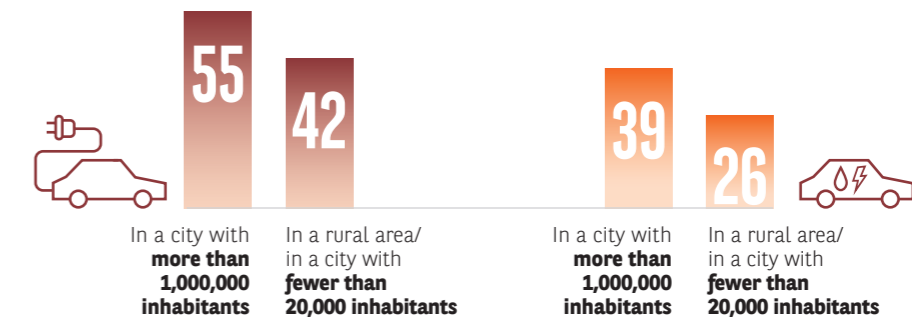
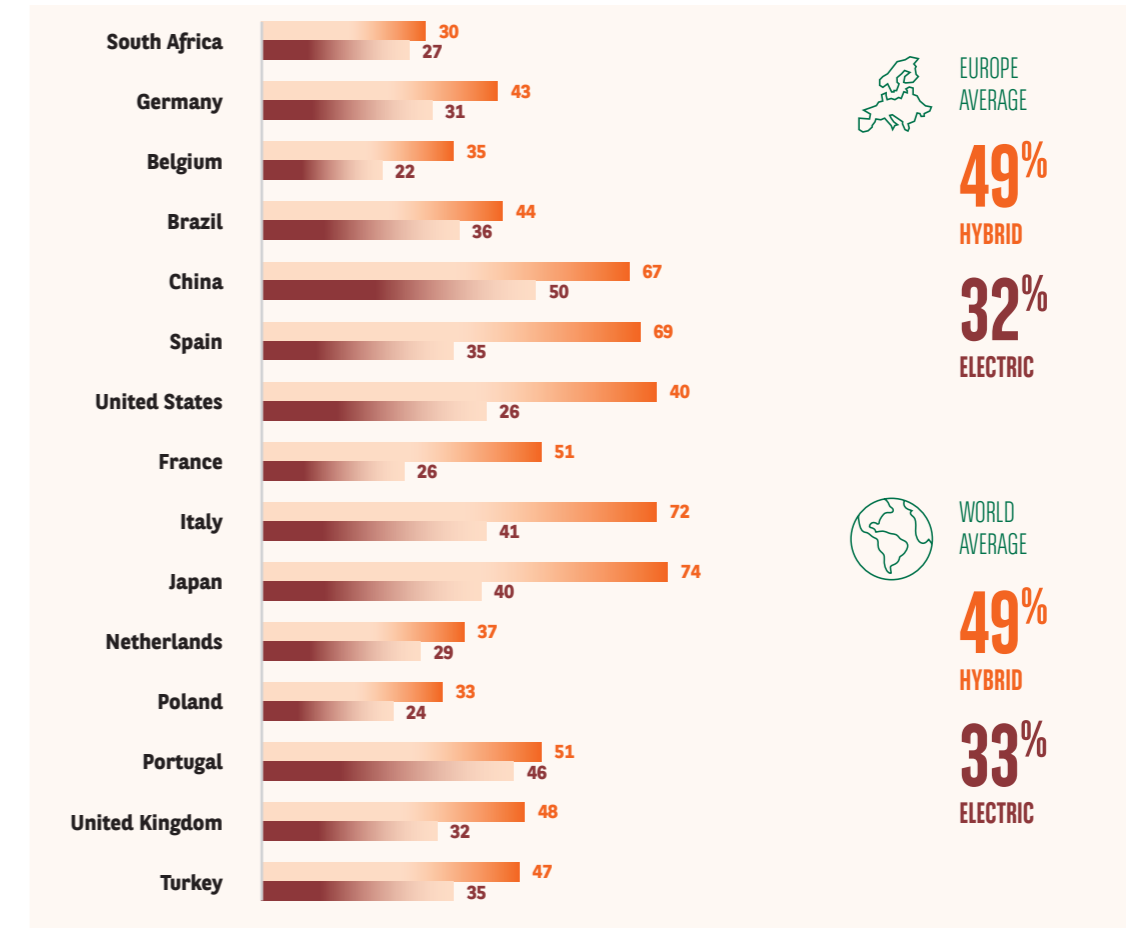

Source: L'Observatoire Cetelem

A BUDGETING ISSUE FIRST AND FOREMOST

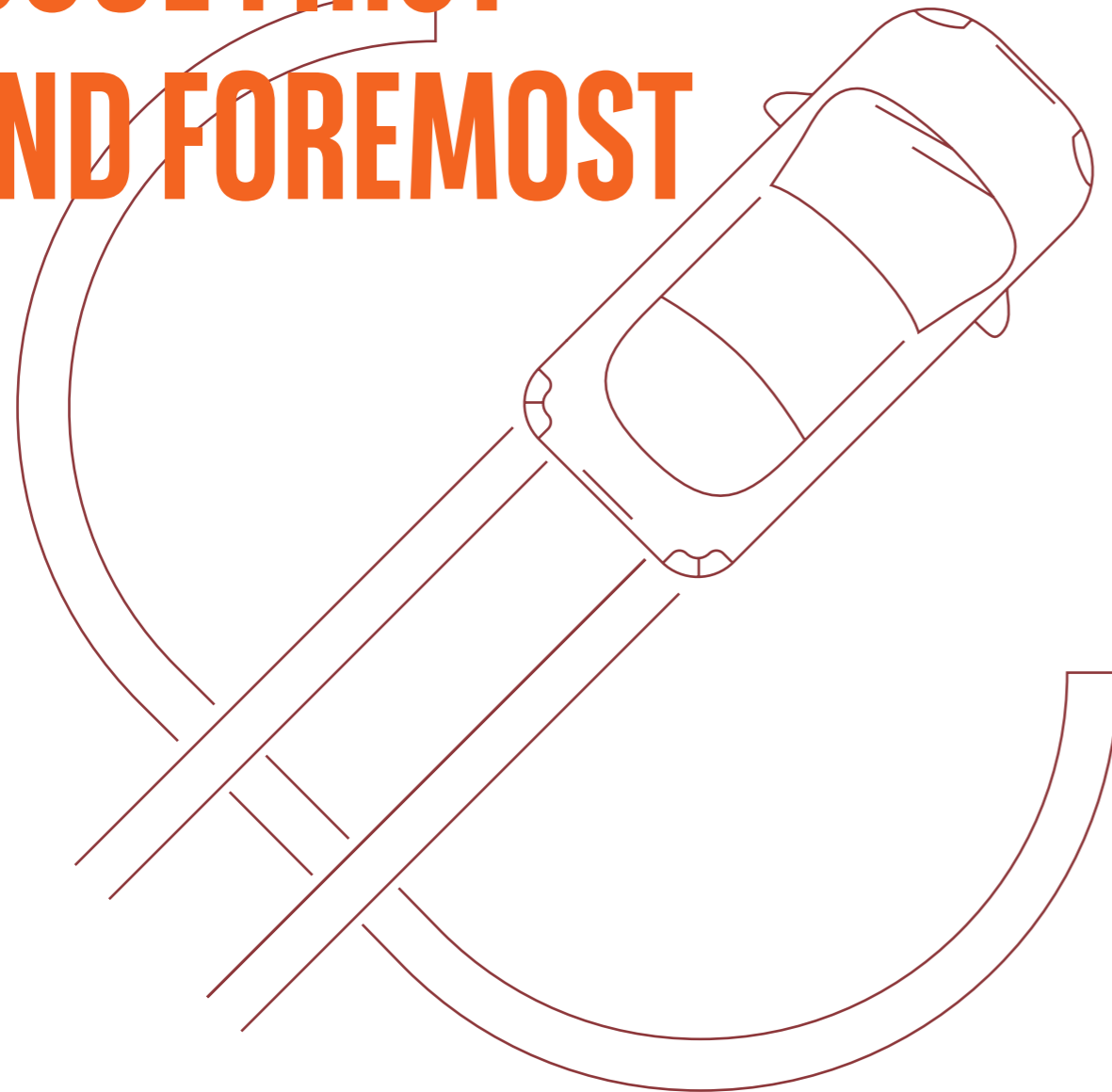
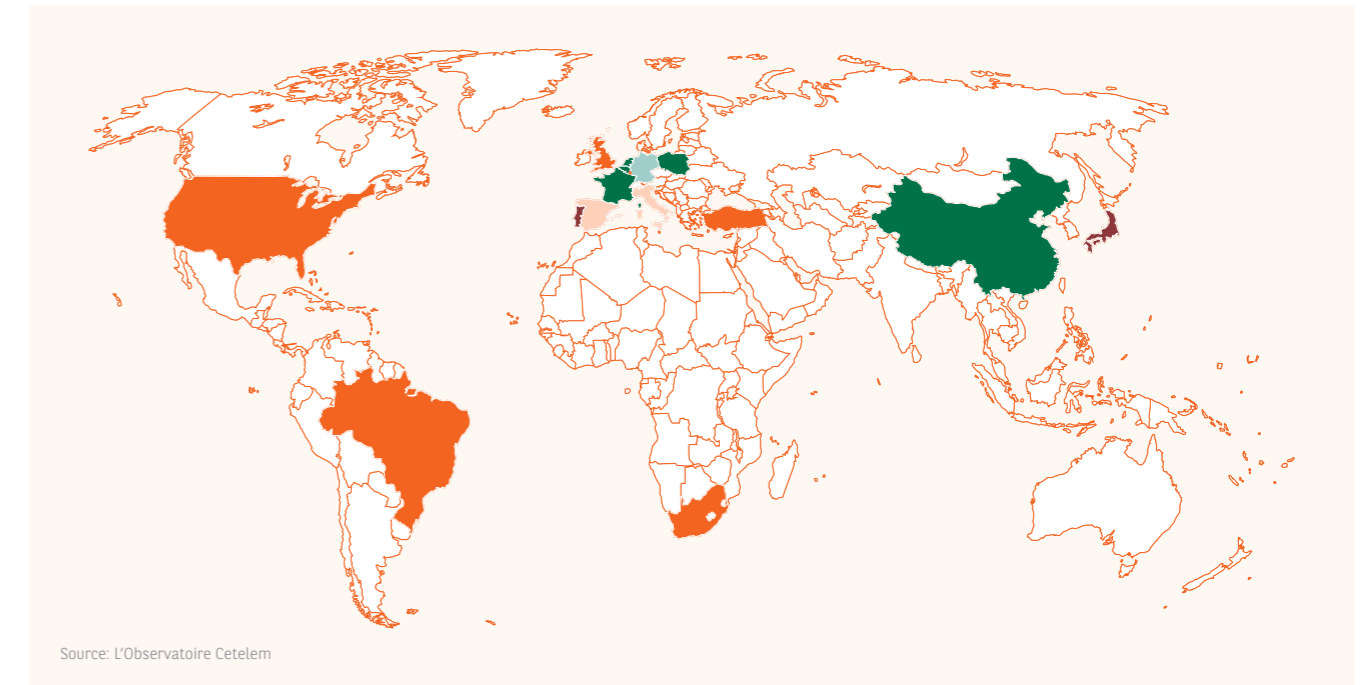

Fig. 19

Why don't you own a car?

In %, several possible answers

The colours represent the majority opinion in each country



Source: L'Observatoire Cetelem

36%

CARS ARE TOO EXPENSIVE TO BUY

34%

I DON'T HAVE A DRIVING LICENCE

34%

THE RUNNING COSTS OF CARS ARE TOO HIGH

25%

I WOULD RATHER USE OTHER FORMS OF TRANSPORT

24%

I DON'T NEED A CAR

While environmental concerns carry significant weight today, economic preoccupations remain dominant. When people who do not own a car are questioned, only 12% say that their decision relates to the environment. For many, cars are just too expensive to buy and their maintenance costs too high (36% and 34%). A high purchase price is more likely to be cited in the “emerging” countries – Turkey, South Africa and Brazil – where living standards are lower. One-third of those surveyed state that the reason is that they do not have a licence (Fig. 19).

RUNNING COSTS EXCEED THE PURCHASE PRICE

Purchase price and running costs are perceived very differently by car owners, but the question of finance remains predominant. Only 18% believe that purchasing a vehicle is a significant outlay. However, 85% of respondents cite fuel as being the most significant expense. This opinion is very strongly held in Poland and Brazil, much less so in the United States and the United Kingdom.

On this topic, which was at the root of the Yellow Vest crisis, the French express an equally clear opinion, with a result that is slightly above average (88%). Insurance and maintenance costs come next in the list (70% and 54%). The Italians, Portuguese and Spanish are the most likely to cite the former (83%, 80% and 77%). The Chinese and Turks are the most sensitive to the latter (70% and 67%).

MILLENNIALS BEAR THE BRUNT OF MOTORING COSTS

Once again, the generation gap is significant when we consider these three main expense items. 89% of millennials, compared with 79% of seniors, put fuel at the top of the list of expenses. The gap is even wider when it comes to insurance and maintenance costs (78% vs. 61%, 60% vs. 46%). These differences seem to be explained by the fact that the young are only just entering the world of work and earning incomes that are typically lower. In the eyes of millennials, the freedom associated with cars comes at a cost. One that is often too high.

Fig. 20 What are your main car-related expenses?
In %, three possible answers

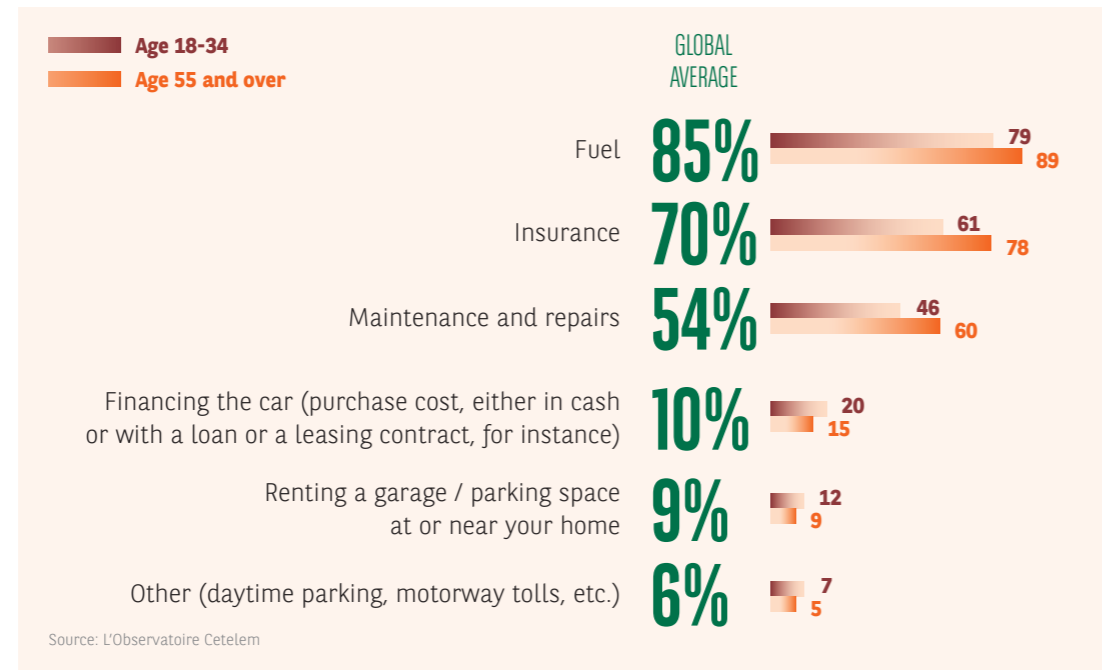

FUEL IS TOO EXPENSIVE, A GOOD REASON TO LEAVE ONE'S CAR AT HOME

The issue of fuel costs also exacerbates the generational divide that is apparent when we examine vehicle use. Overall, 1 in 2 respondents have given up on the idea of having a car due to the cost. This is true of 63% of millennials, but only 46% of over-55s. The gap is widest

in the United Kingdom, where the young are three times more likely than their elders to turn their back on driving due to the price of fuel. In France and Spain, the difference is also significant (+24 and +21 points). Only Turkey stands apart, with seniors who are more sensitive to price than their younger compatriots (Fig. 21 and 22).

Fig. 21 Do you sometimes give up on using your car to travel because of fuel prices?
In %, sum of "Yes" answers, only one possible answer

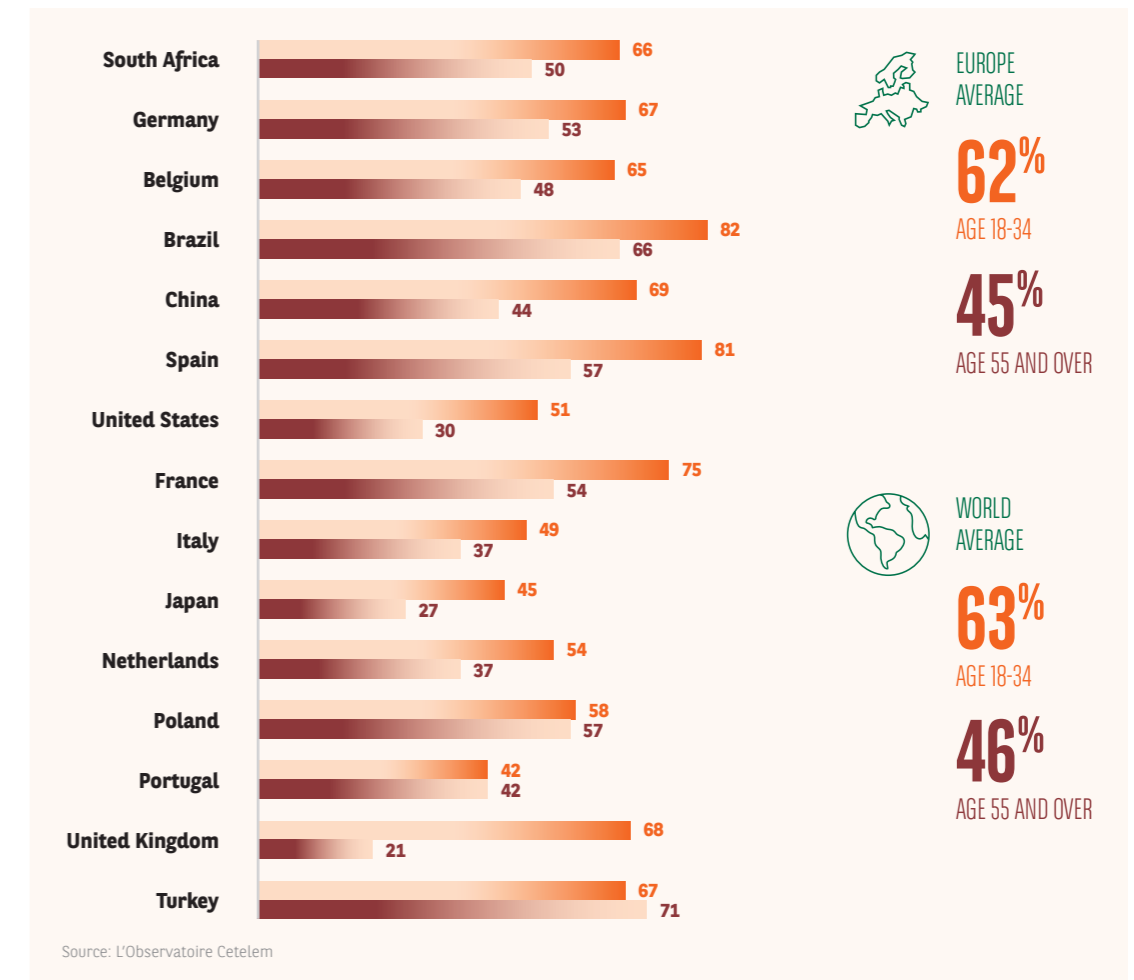
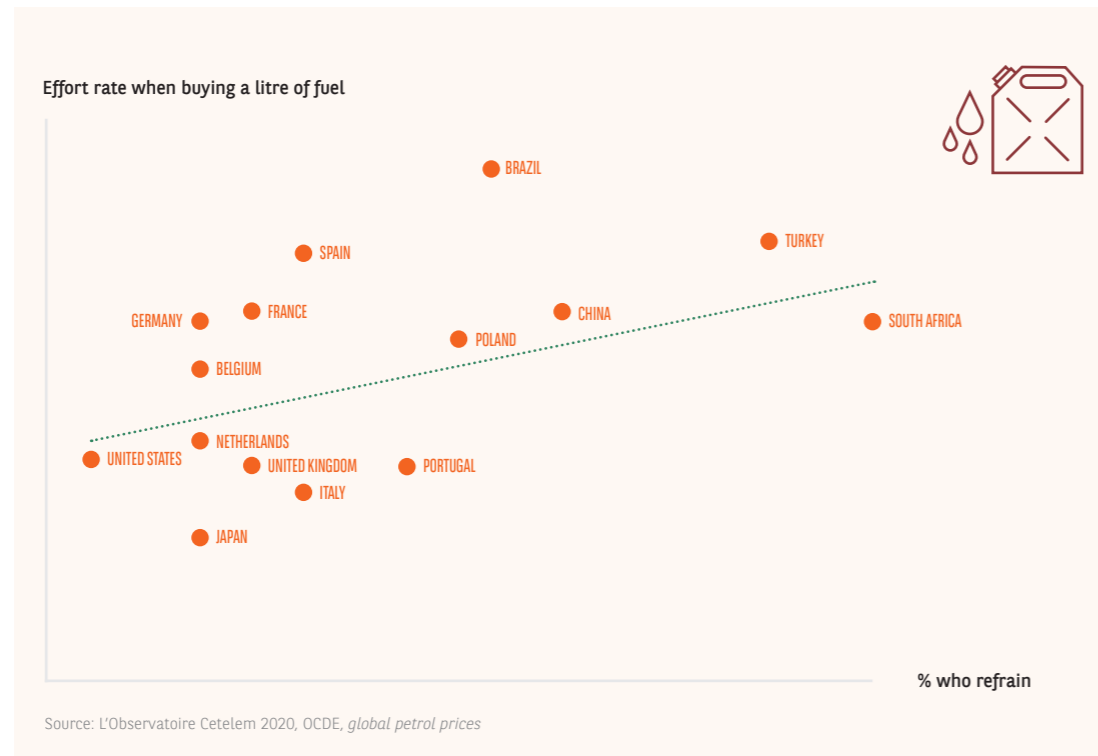

Fig. 22

Relationship between the effort rate when purchasing a litre of fuel and the decision not to travel by car

Effort rate: relationship between the price of fuel and GDP per capita



SENIORS AND RURAL POPULATIONS: LESS TAX, MORE MONEY

Another question asked to motorists confirms that, for them, the issue of fuel is ultimately a financial one rather than an environmental one. When asked whether governments should raise fuel taxes to promote greener forms of transport or lower them to increase purchasing power, the response is clear. 61% are in favour of the second option, while only 18% favour the first. Seniors are the most likely to support the idea of lower taxes (65% vs. 55% of millennials).

Probably because it is harder for them to live without their car, rural dwellers are also keener on this measure than those who live in big cities. France is where the gap is the widest (25 points). Geographically speaking, the generational differences are most striking in South Africa, Turkey, the Netherlands, Belgium and France. The Chinese stand apart in preferring to increase taxes so as to protect the environment. Given the high levels of air pollution they face, 44% of the country's population would opt for such measures, compared with just 34% who would prefer to see their purchasing power rise (Fig. 23).

Fig. 23

Do you believe it would be preferable to...

In %, only one possible answer to each of the two suggestions

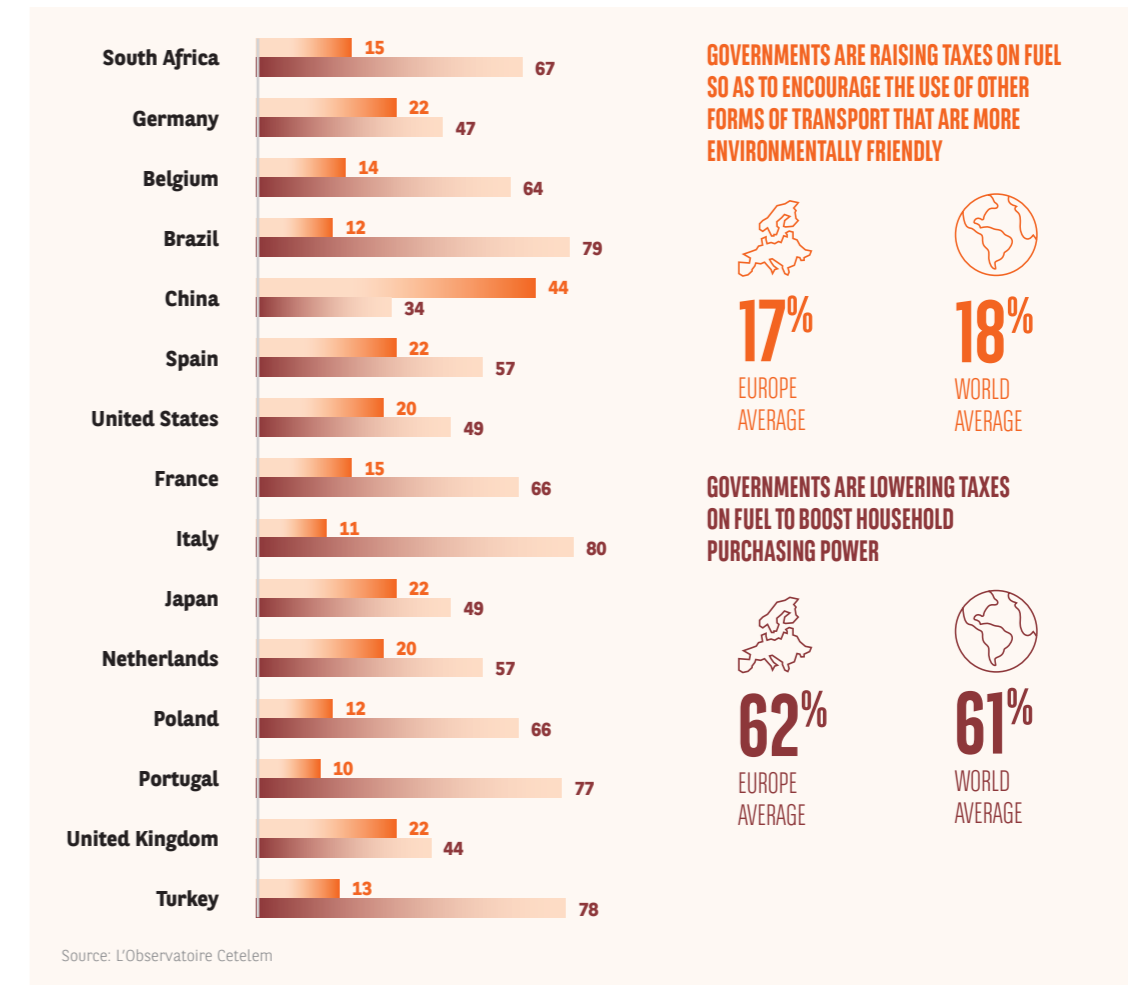

DRIVING LESS TO SPEND LESS

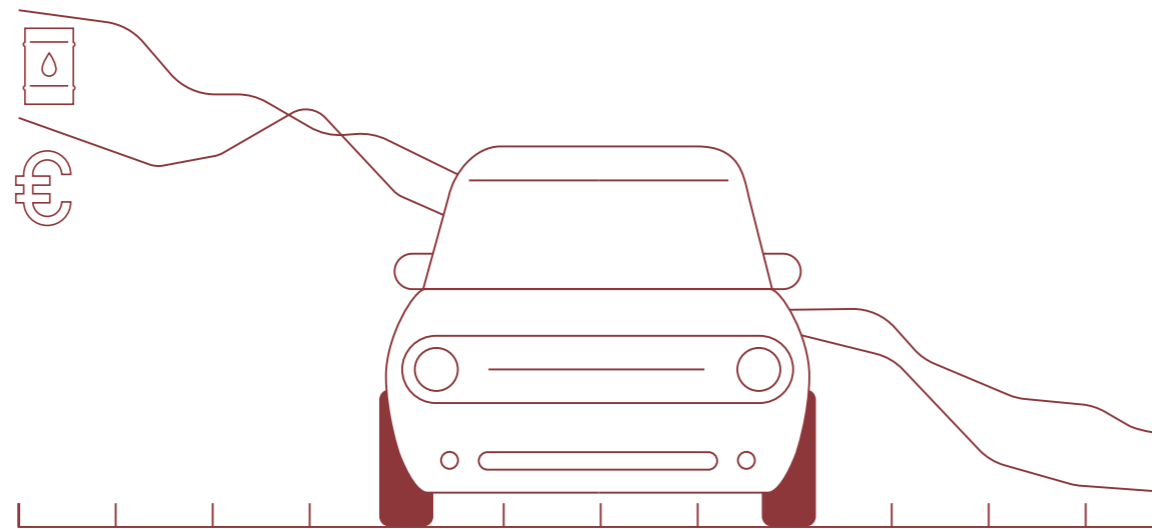

MEASURES HAVE ALREADY BEEN TAKEN TO CUT RUNNING COSTS

In order to face up to budgeting and financial issues, motorists have adopted various measures to reduce their motoring costs. 4 out of 10 drive less, with the Japanese being the most reluctant to reduce their mileage (26%). The same proportion prefer to buy a used or more fuel-efficient vehicle, reduce their insurance costs by using comparison websites, or avoid toll roads. Switching to another form of transport is another option, one favoured in particular by the Chinese, the Turks and the Brazilians. Conversely, only an indomitable 18% of Americans prefer this solution. It is worth noting that only 9% of Chinese respondents opt for used cars,

by far the lowest percentage of all the countries in the study, although it must be said that the country's second-hand market is yet to be properly structured (Fig. 24).

OTHER POSSIBLE SOLUTIONS: A COMBINATION OF OPTIONS

For those who have not yet taken budgetary measures, the range of solutions on offer is somewhat different. First and foremost, they intend to take advantage of scrappage premiums, green-vehicle premiums, etc. (41%). Their second-favourite option is to drive less (34%). The next is to spend less on a new car (33%). These three solutions generate fairly similar responses in all countries.

Fig. 24

To reduce your vehicle costs, would you be willing to...

In %, sum of "I do so already and intend to continue", only one possible answer

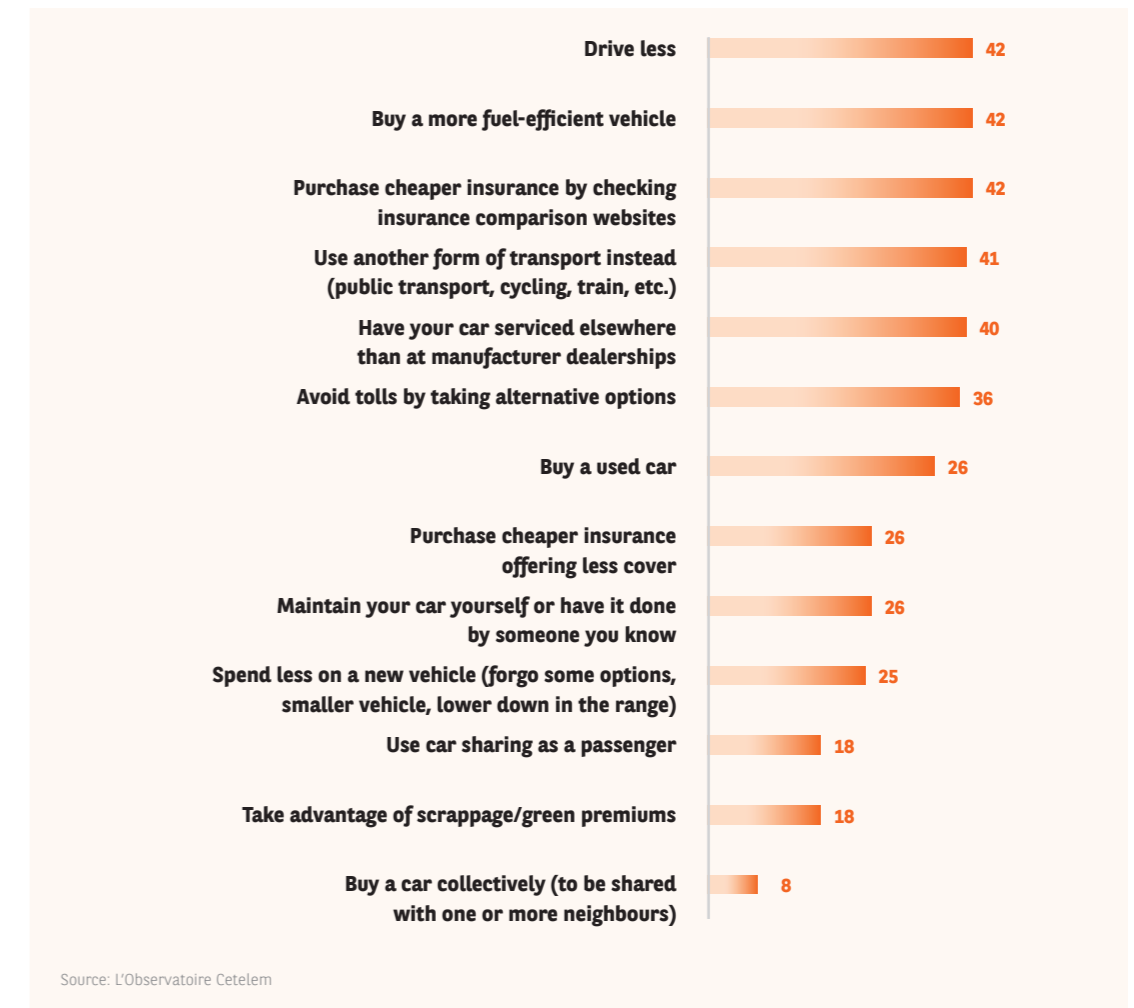

However, also of interest to motorists is a fourth way of reducing their vehicle costs. Indeed, 1 in 4 are now considering ride sharing, with 18% already using such services as passengers. This is a practice in which the Chinese lead the world. 32% already partake in car sharing as a passenger to reduce the amount

they spend on their car, while also resolving the vexed issue of parking, which is a major problem in Chinese cities. Those in emerging countries also regularly engage in the practice. This is probably due in great part to the adoption of car sharing to commute to work more cheaply (Fig. 25).

Fig. 25

To reduce your vehicle costs, would you be willing to...

In %, sum of "You have never done so, but would be prepared to try"

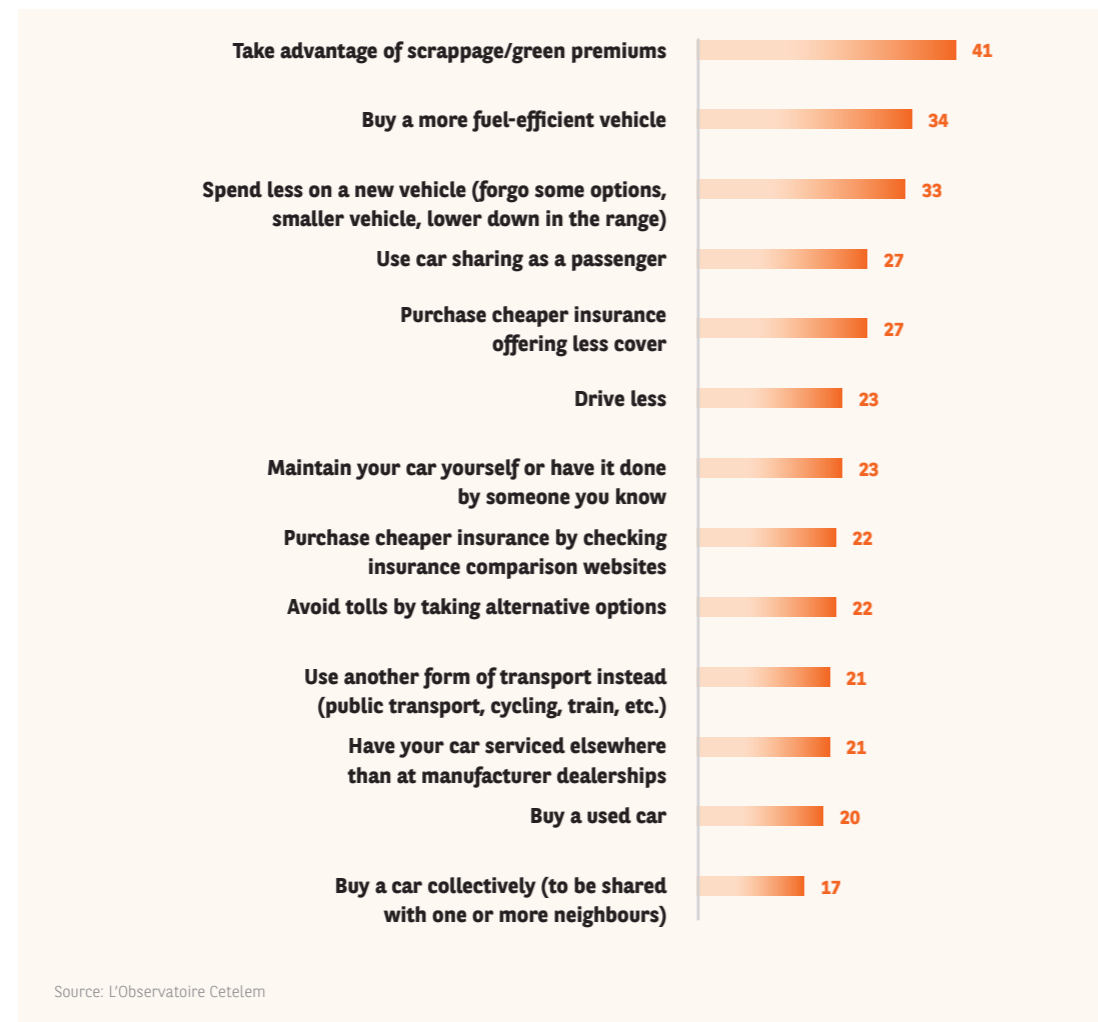

SUMMING UP

KEY FIGURES

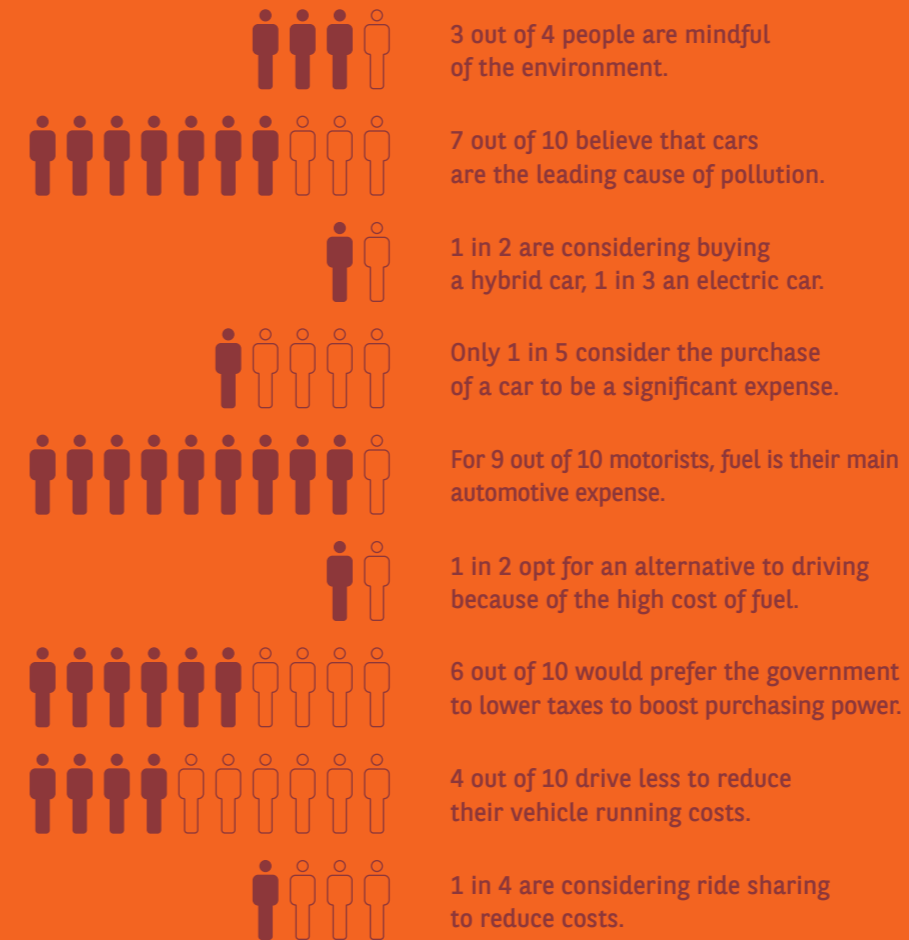

SCHISMS

- Emerging countries, millennials and urban dwellers are twice as likely to consider cars to be the leading source of pollution.
- There has been a major surge in hybrid and electric vehicle purchase intentions, especially in urban areas.
- Faced with high fuel costs, more millennials than seniors give up on using their cars.
- Seniors and rural populations are more in favour of lowering taxes to boost purchasing power.
- Ride sharing as a passenger is most common in the emerging countries and China.

NEW MOBILITY SOLUTIONS THAT ARE YET TO PROVE THEIR WORTH

Purchase, use, wear out, replace... The era of the traditional vehicle life cycle appears to be over. The schisms listed above are prompting the emergence of new solutions. Some have already seen the light of day, while others are still being examined. But do they have a long-term future? Will they be able to overcome the obstacles they face and satisfy expectations that differ among clientele categories, countries and types of residential area?

REINVENTING MOTORING THROUGH SERVICES

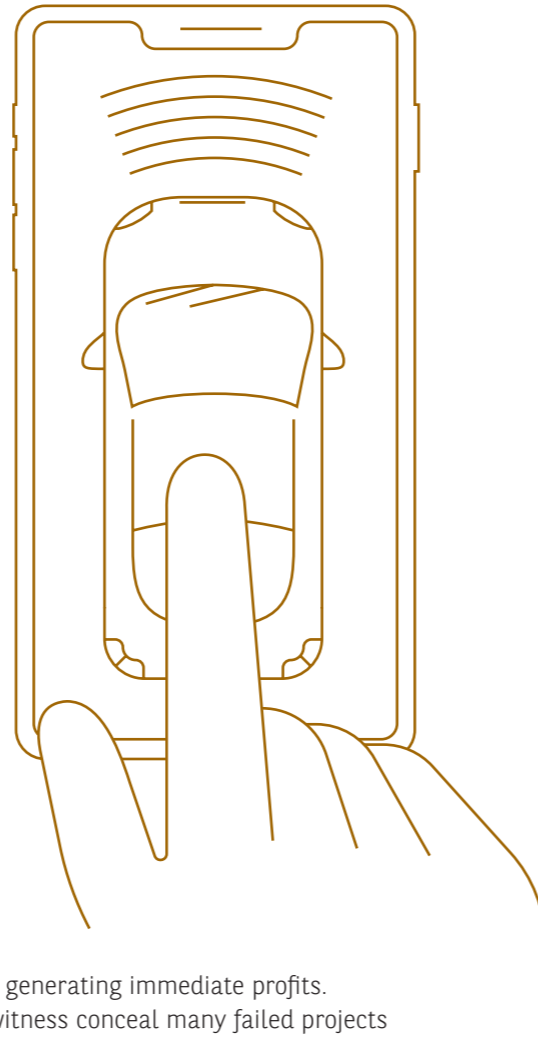

The automotive sector has entered a period of creative vibrancy that it has rarely experienced before. New technologies are reinventing the car. Service-based solutions are primarily geared towards meeting the challenge posed by traffic flows in congested and polluted cities. The profitability and therefore the sustainability of these offerings raise certain questions. The development of leading brands requires significant capital investment,

without necessarily generating immediate profits. The successes we witness conceal many failed projects that vanish almost as quickly as they appear. The biggest players acquire the smallest. What's more, the creation by major car brands of global mobility approaches highlights the reality that cars still need to hold a certain appeal and build their future around new practices such as ride sharing and car sharing.

Global automotive mobility services

	Acquisition	Investment	Subsidiary	Partnership
	-			
	-		-	
	-	-	-	
	-		-	
	-	-	-	
	-		<small>Toyota Research Institute Advanced Development, Inc.</small>	
	-			
	-	-	-	

Source: <https://www.cargroup.org/disrupted-by-mobility-startups-automakers-reshape-their-roles/>

The United States and Asia, the two major hubs for new mobility solutions

The United States and Asia, China in particular, are clearly at the forefront of new mobility solutions, thanks to their industry-leading brands. But beyond their stock market attractiveness, these firms still have to convince the world of their ability to generate sustainable profits.

- DiDi, a Chinese ride-hailing service
- Uber, an international ride-hailing and delivery service
- Grab: a Southeast Asian ride-hailing and delivery service
- Lyft, an American ride-hailing service
- Airbnb

AUTOMOTIVE MOBILITY SERVICE OFFERINGS

Estimated value of the company in billions of dollars (n years after stock market flotation)

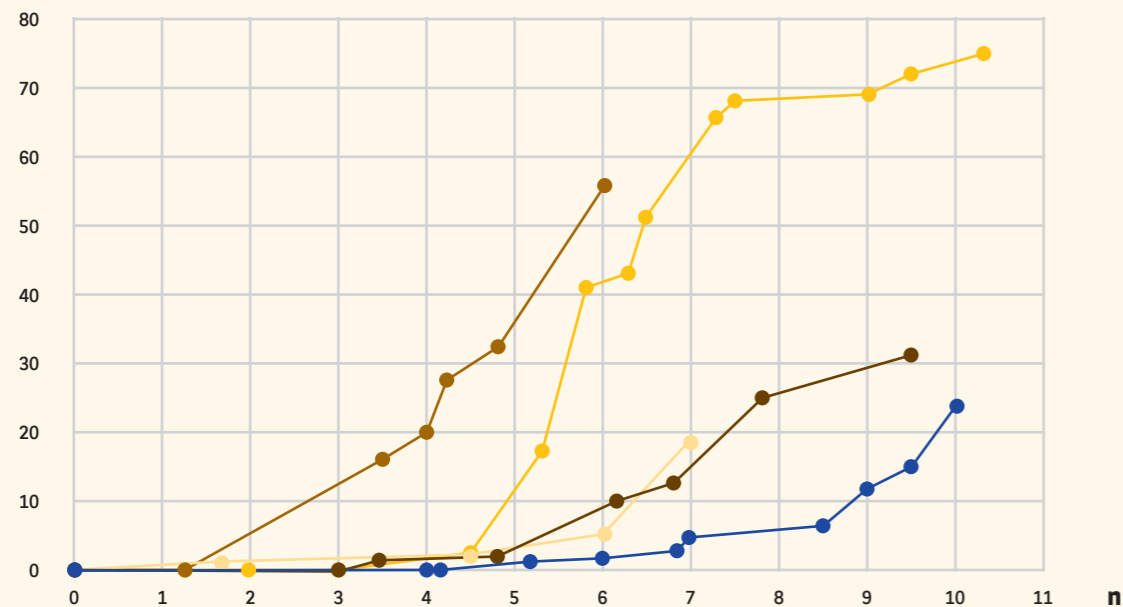

Source: <https://travelandmobility.tech/infographics/>

DIFFERENT OPTIONS FOR A DIFFERENT APPROACH TO MOTORING

To travel by car without having to own one, a number of services are available:

- Car sharing, i.e., a fleet of cars made available to consumers by public or private operators. This type of solution is now available as a direct peer-to-peer service, supported by digital firms (e.g., US company Getaround, which acquired France's Drivy in 2019).

- Another option is ride sharing over short or long distances, whether it be for commuting purposes or for holiday travel (Blablacar, the global leader in ride sharing, is based in France).
- Meanwhile, long-term hire, with or without the option of buying the car when the contract expires, was devised to attract the growing number of motorists who are less interested in ownership. Today, motorists are even being invited to rent out the vehicle that they themselves are hiring...

Both renter and rentee

Car leasing has grown at a rapid rate in recent years. Like other living expenses, cars are gradually being switched over to the subscription economy, with consumers treating them as a service instead of taking ownership of an item that is subject to wear and tear. There are many advantages for consumers: they always have use of one of the latest cars, because they are able to regularly replace it, there are no uncertainties over residual value and no concerns about a future part exchange or having to sell the vehicle second hand. The benefits for society are also significant, given that more new and therefore greener vehicles are on the road.

"We can do even more and we can do it better," says Jean-Claude Puerto-Salavert, an entrepreneur specializing in car rental and the CEO of Ucar. An advocate of the sharing economy, Jean-Claude recently launched Ucar2share in France, an "alternative leasing" system that offers its customers a substantial discount on their rent in exchange for making their car available to others for a few days a month. Once considered exclusive and purely as being expense items, cars are becoming a collective asset and a source of income for leaseholders. Meanwhile, short-term rental offerings are expanding and becoming more accessible to a whole community of people who do not have their own car. "Having been the symbol of individual freedom in the 20th century, cars are set to become champions of the freedom offered by sharing," predicts Jean-Claude Puerto-Salavert.

UNITED STATES, EUROPE AND CHINA: MICROMOBILITY HAS A BRIGHT FUTURE

Estimated size of the micromobility market in 2030 by region, in billions of dollars

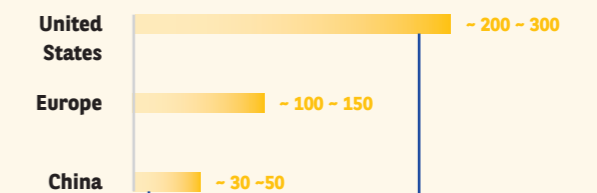

The price of micromobility services stands at just ~20% of that applied in the United States

~ 47.5 million people cycle regularly

Source: www.mckinsey.com/industries/automotive-and-assembly/our-insights/micromobilitys-15000-mile-checkup

RIDE SHARING: A FINANCIAL IMPERATIVE

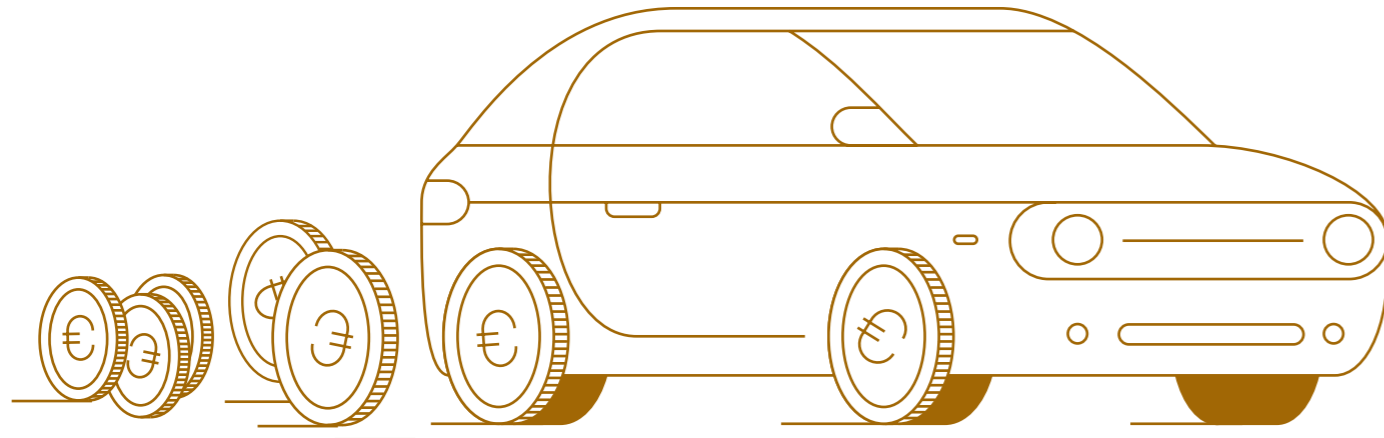

AN AFFORDABLE OPTION, ESPECIALLY IN EMERGING COUNTRIES

People often use ride sharing for financial reasons, whether as a passenger or a driver (Fig. 26 and 27). 51% of the former do so to save money, while 44% of the latter do so for that reason. Environmental concerns come second (35% and 38%).

South Africa, Turkey and Brazil have the highest proportions of drivers who partake in ride sharing for economic reasons. Conversely, the Germans and especially the Japanese tend not to be preoccupied by the thought. The French post a close-to-average score.

Fig. 26 and 27

What are (or would be) your main motivations for ride sharing as a driver?

In %, maximum of three answers

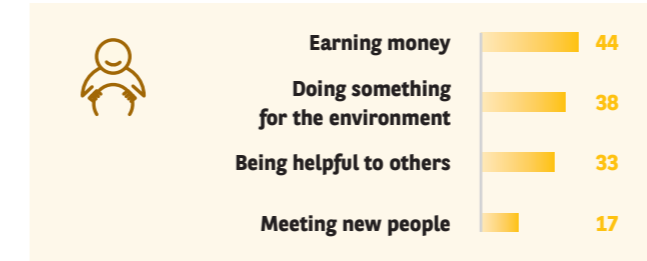

What are (or would be) your main motivations for ride sharing as a passenger?

In %, maximum of three answers

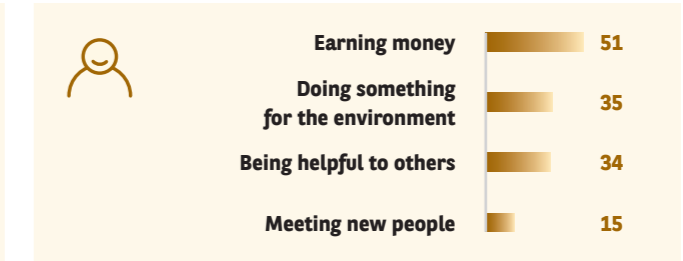

Source: L'Observatoire Cetelem

FOR MILLENNIALS, EARNING MONEY IS THE PRIORITY

The generational divide is just as significant here. Millennials are much more likely than their elders to consider ride sharing to earn money. Even more striking is the fact that seniors are more mindful of environmental aspects. However, the social aspects of ride sharing

are also cited by a large proportion of millennials, be they passengers or drivers. However, the difference between urbanites and country dwellers is not huge. Their reasons for ride sharing are almost identical, with a priority placed on financial concerns (Fig. 28).

Fig. 28

What are (or would be) your main motivations for ride sharing as a passenger?

In %, maximum of three answers

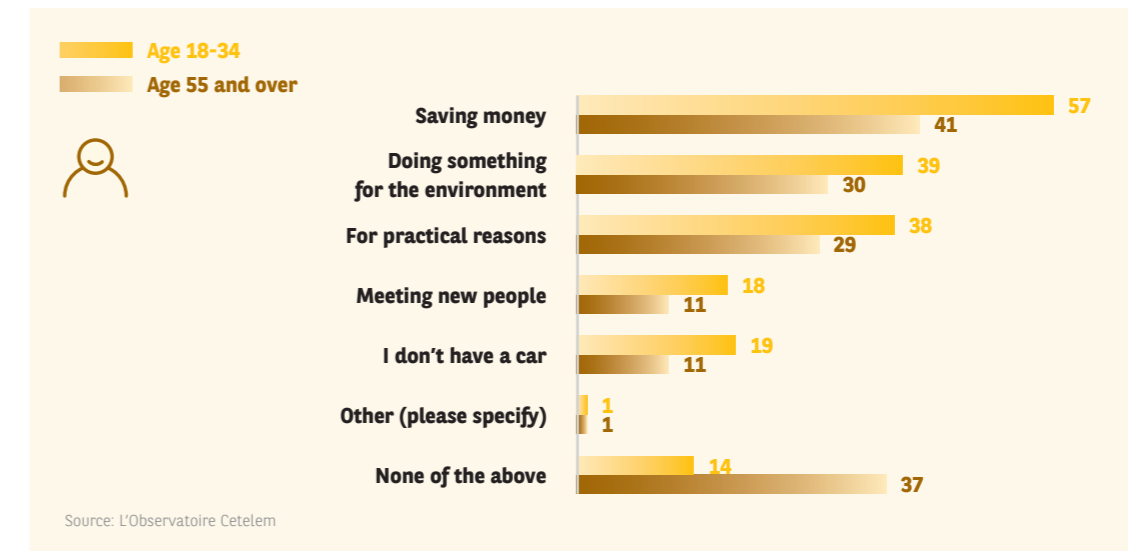

Source: L'Observatoire Cetelem

REJECTING RIDE SHARING: MONEY ISN'T EVERYTHING

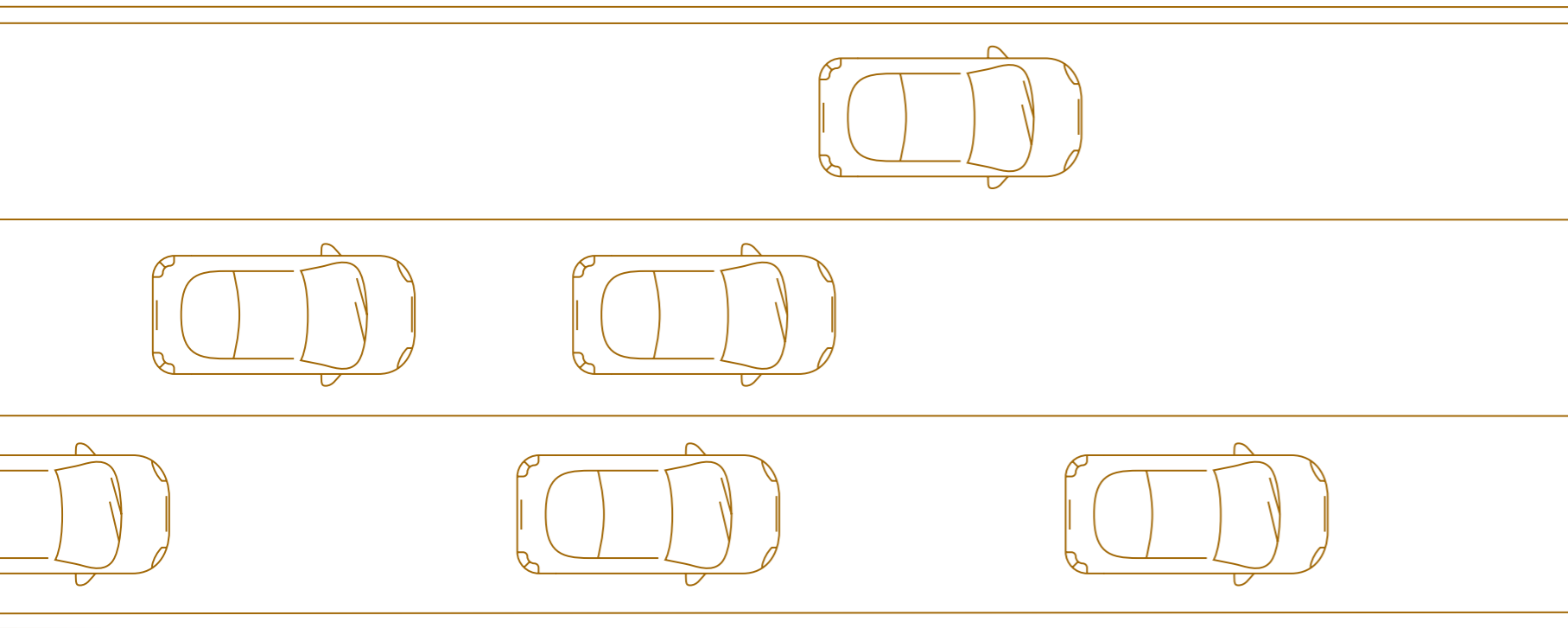

THE YOUNG LIKE TO CHOOSE WHO THEY TRAVEL WITH

The reasons why people avoid ride sharing are completely unrelated. Many passengers simply prefer to drive (44%), especially seniors (46%), with fewer millennials sharing this view (38%). This attitude is most prevalent in the United States and Germany, with the Japanese being the happiest to let someone else drive.

Millennials also like being able to decide who they travel with (31%). This generation's keenness to travel with friends probably explains this view. This point is important to South Africans and Turks, much less so to the Italians, Japanese and Belgians (Fig. 29).

Fig. 29

What are the main reasons why you do not/no longer ride share as a passenger?

In %, maximum of three answers

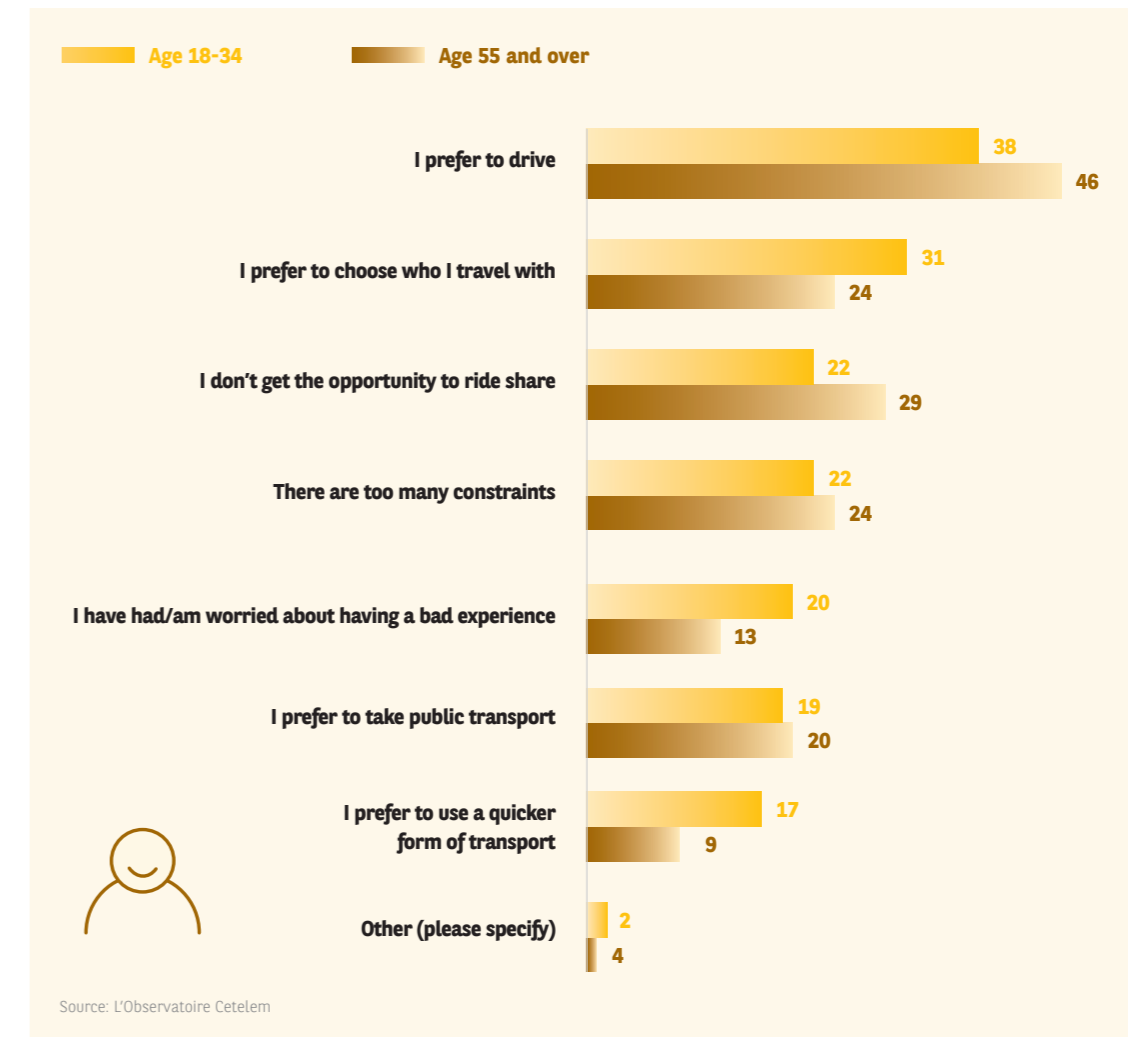

IN RURAL AREAS, RIDE SHARING IS NOT REALLY AN OPTION

Urbanites and rural populations do not have the same level of access to ride sharing. 35% of country dwellers don't have the opportunity to ride share, compared with just 20% of people in cities. Conversely, while 28% of inhabitants of large cities prefer public transport,

this is only true of 14% of those who live in smaller towns with fewer services. Lastly, one-quarter of respondents believe that ride sharing comes with too many constraints. And for once, young and old, urbanites and country dwellers, all cite this point in similar proportions (Fig. 30).

Fig. 30

What are the main reasons why you do not/no longer ride share as a passenger?

In %, maximum of three answers

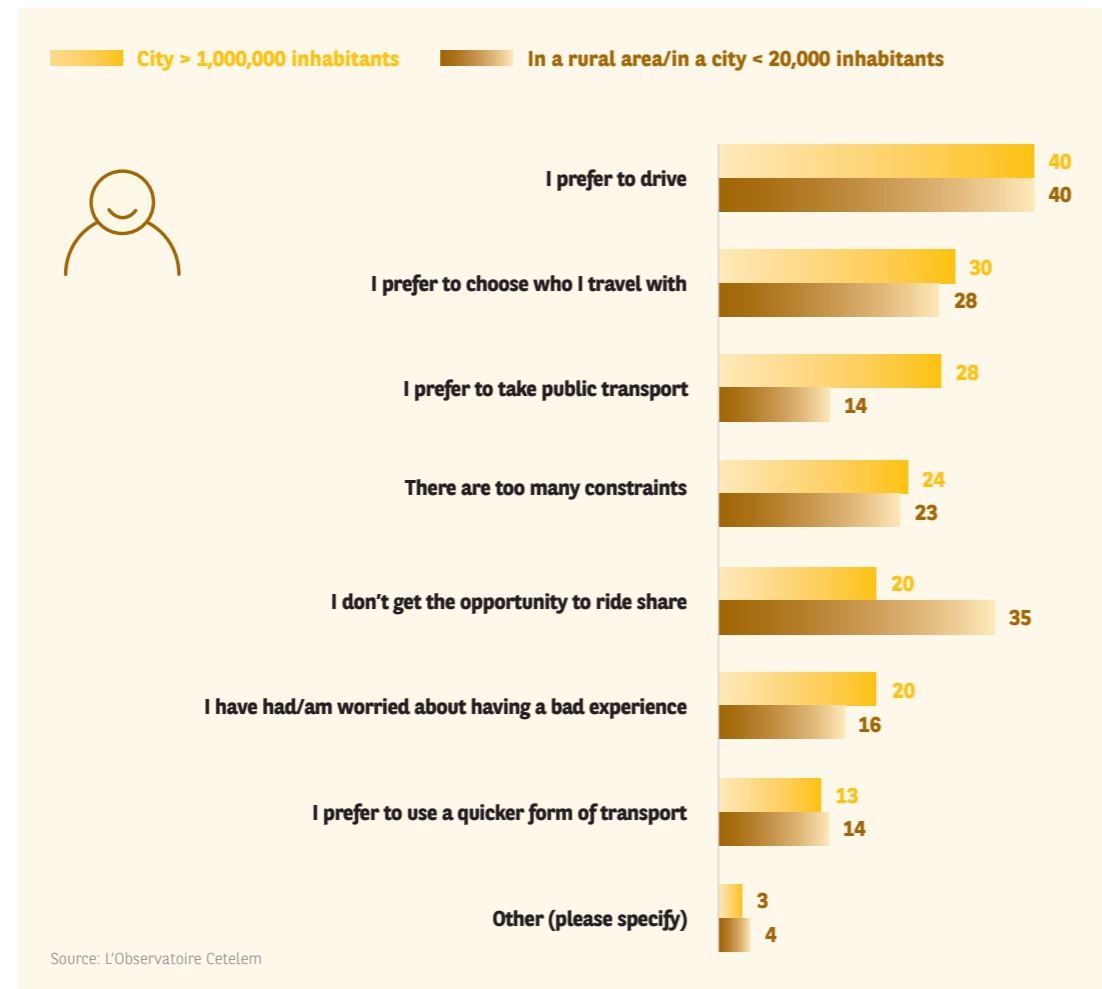

SENIORS WANT TRAVEL FREEDOM, MILLENNIALS ARE MORE APPREHENSIVE

For drivers, the constraints inherent to ridesharing prevent them from embracing the practice. Seniors are keener than millennials to preserve their travel freedom (38% vs. 32%), 35% of respondents also state that they do not want to take any risks. Identical reasons are given by millennials and seniors, urbanites and country dwellers. One nation, Brazil, stands apart with 54%, probably due to a strong sense of fear about safety. Millennials are also more likely to cite previous bad experiences as a reason for giving up ride sharing (25% vs. 14%). Drivers who have been left with a negative perception tend to live in cities, which is the case in Turkey, Japan or China (Fig. 31).

Ride sharing: fears over safety

35%

of people avoid ride sharing because they do not want to take any risks. This is a choice that seems justified by experiences in China. Following two murders in July 2018, the Chinese government banned ride sharing services based on ride hailing. In July 2019, these services were still suspended. At the time, DiDi had not yet set a timetable for their resumption.

Fig. 31

What are the main reasons why you do not/no longer ride share as a driver?

In %, maximum of three answers

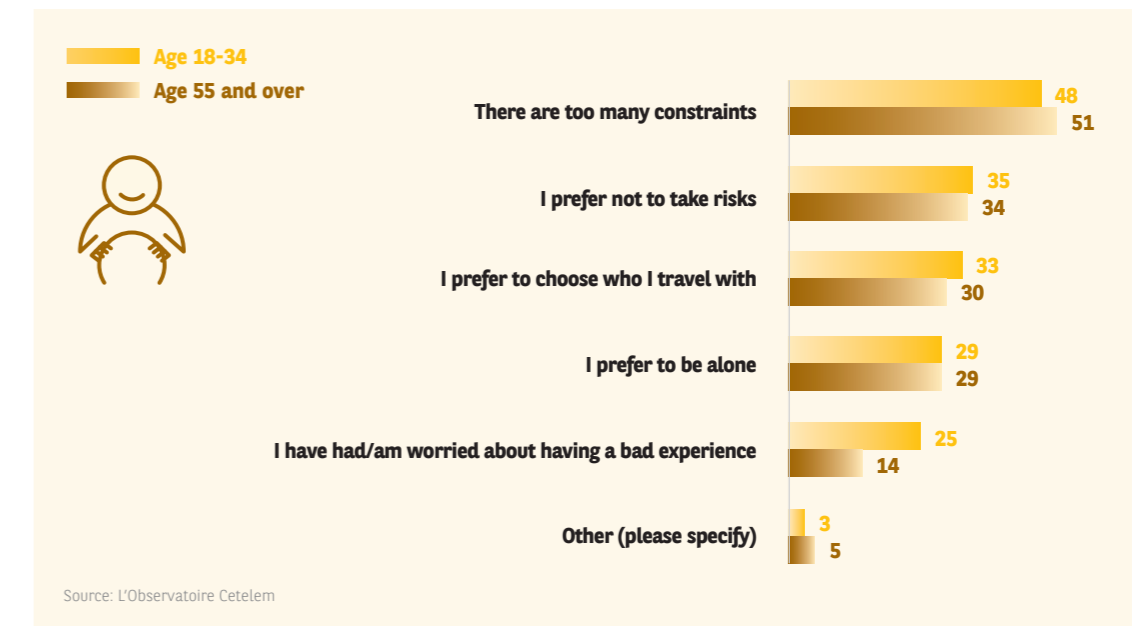

CAR SHARING: THE ADVANTAGES REMAIN TO BE CONFIRMED

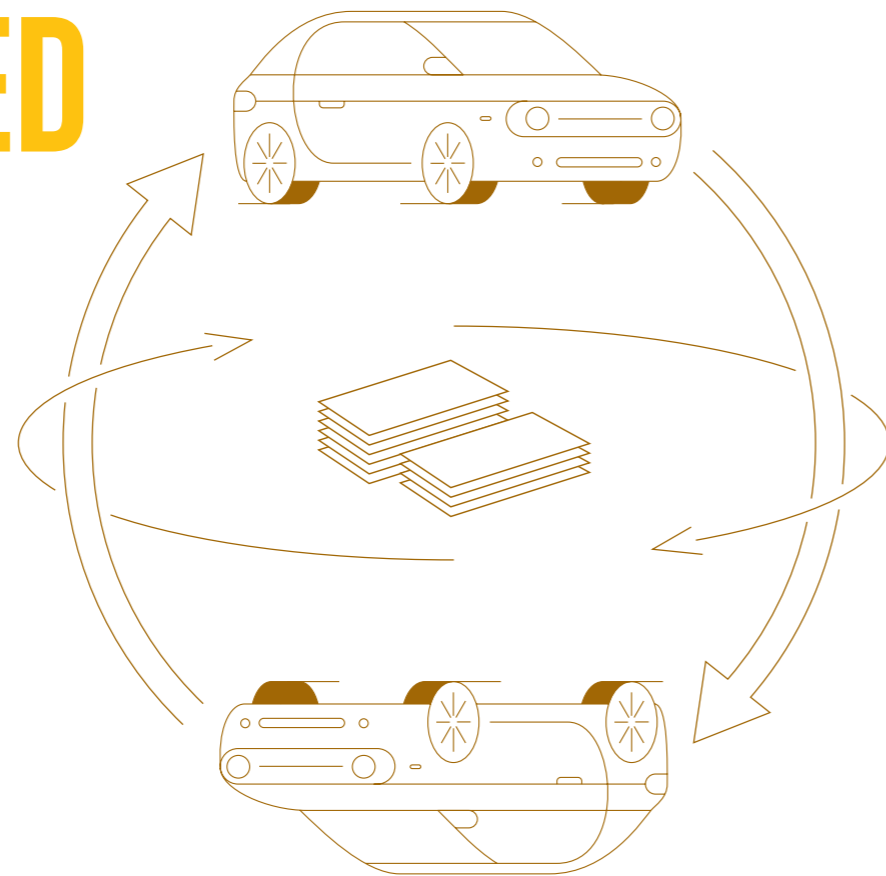

EARNING MONEY YES, BUT THAT'S NOT ALL...

Economic factors are the number one motivation cited for ride sharing. They are also the main reason why people engage in car sharing, on a par with concern for the environment and basic practicality. These three reasons generated almost equal scores, whether it be on the topic of peer-to-peer car sharing (49%, 49% and 46%) or car sharing through a private company (29%, 29% and 28%). It should be highlighted that financial motivations are more predominant in South Africa, Brazil and Turkey (Fig. 32 and 33).

MILLENNIALS ARE ALWAYS KEEN TO PROFIT

A generational analysis again reveals clear differences, albeit with a certain degree of nuance. As usual, one could

be tempted to say, millennials view car sharing through private companies or with other private individuals as a way of earning money (36% and 47%). They also engage in the practice due to environmental concerns (33% and 46%) and for practical reasons (27% and 42%).

SENIORS ARE OPEN TO NEW HORIZONS

There is a distinct lack of symmetry in the answers of seniors. Their reasons for car sharing are rooted in environmental and practical concerns, while financial reasons follow in third place. However, seniors are more likely than millennials to want to earn money through peer-to-peer car sharing (50% vs. 47%). This is an atypical result that is worth underlining (Fig. 34 and 35).

Fig. 32 and 33

What are (or would be) your main motivations for car sharing through a private company (Citiz, Car2Move, etc.)?

In %, maximum of three answers

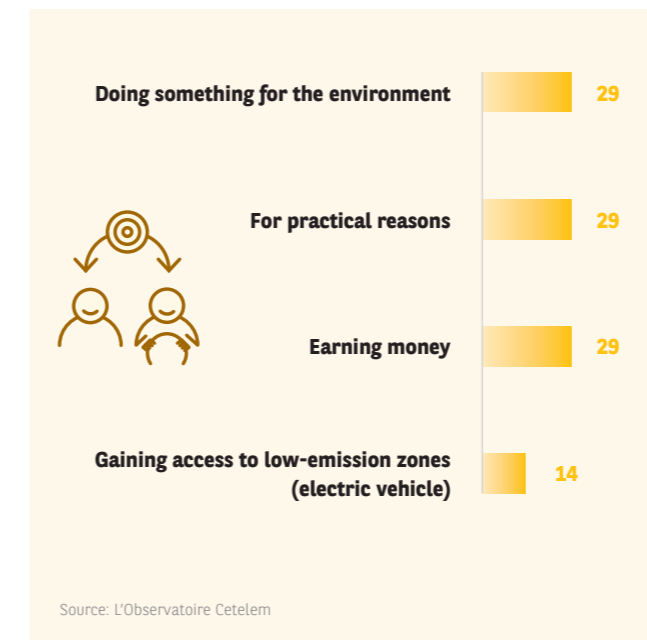

What are (or would be) your main motivations for car sharing with other individuals?

In %, maximum of three answers

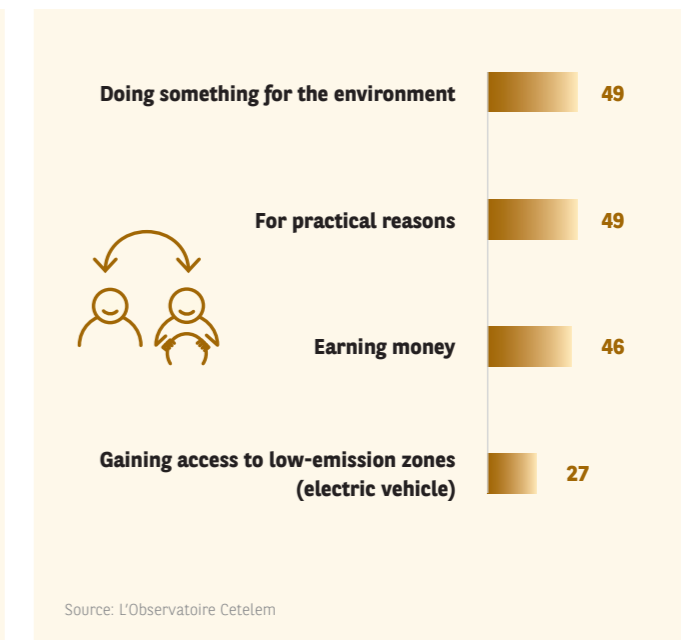

Fig. 34

What are (or would be) your main motivations for car sharing through a private company (Citiz, Car2Move, etc.)?

In %, three possible answers

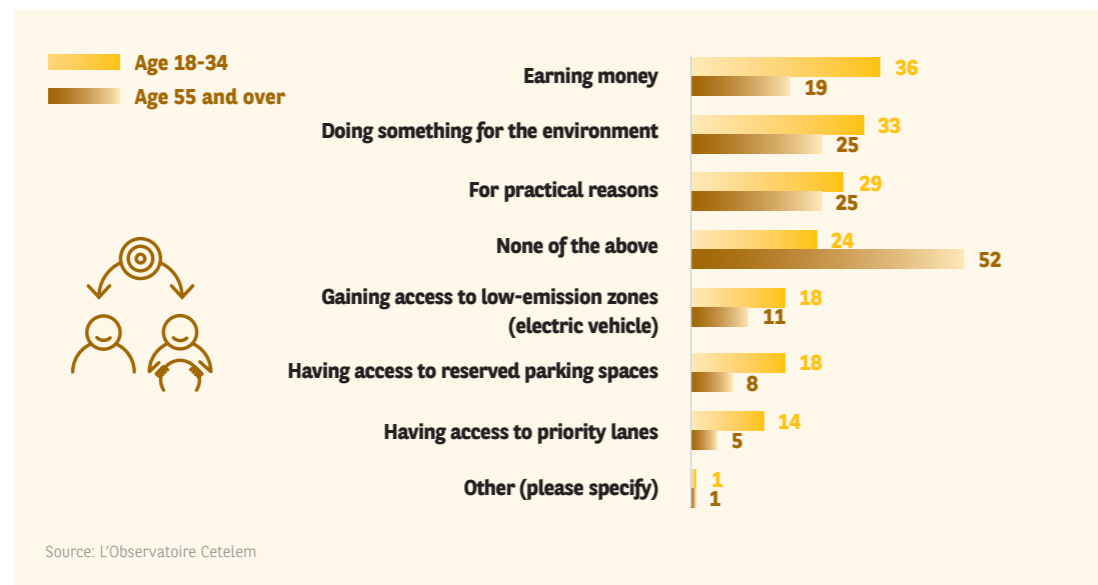

Fig. 35

What are (or would be) your main motivations for car sharing with other individuals?

In %, three possible answers



ALLOWING OTHERS TO USE ONE'S CAR: A NORTH-SOUTH DIVIDE

People's resistance to car sharing remains considerable when it comes to making their own vehicle available to others. A dividing line separates Western economies from emerging countries. 1 in 2 inhabitants of the former (except for Poland and Italy) would not even consider it for one day. On the other hand, only 1 in 3 Turks, South Africans and Brazilians, not to mention only 1 in 5 Chinese, categorically refuse to make their vehicles available for car sharing.

Identical differences appear regarding the question of average duration. The figure is 7.5 days in China, three times more than in Germany and the Netherlands, the two countries at the bottom of this ranking (Fig. 36). The monthly sum that would prompt motorists to accept car sharing suggests their their opposition is not so clear. At the top of the list, the Japanese would require a fee twice as high as the Chinese, who can be found at the bottom. The respective living standards of the two countries partly explain this gap (Fig. 37).

Fig.36

How many days per month would you be willing to make your vehicle available for car sharing (with the days planned in advance)?

In %, only one possible answer

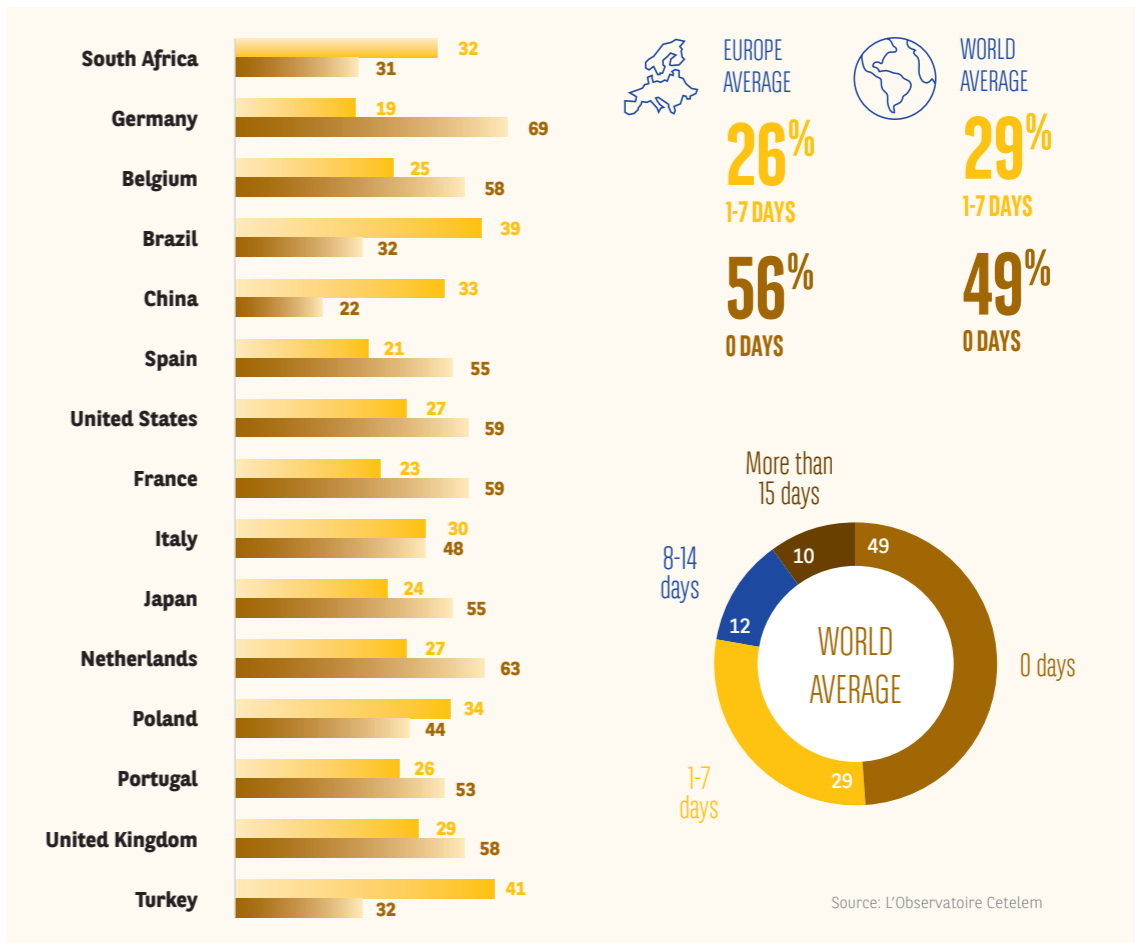
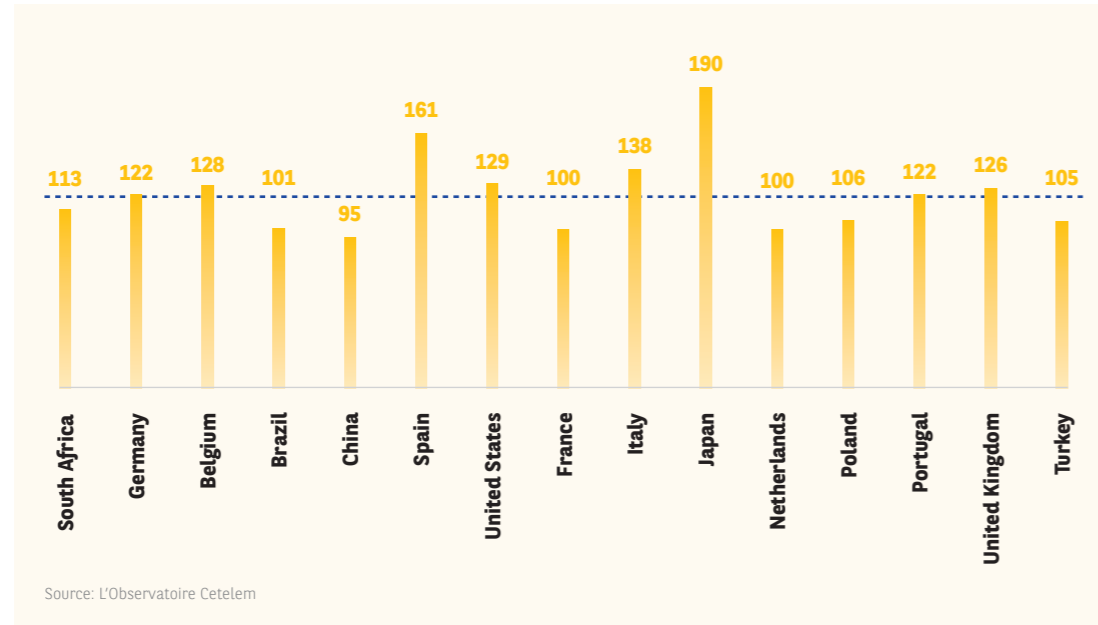

Fig. 37

How much financial compensation per month would you accept to make your vehicle available for car sharing?
In %, only one possible answer. In euros.



Car sharing: Asia leads the way

When it comes to car sharing, the Asian market clearly leads the way ahead of Europe and the United States, thanks to its continued and sustained development. China's contribution is obviously significant, with companies growing thanks to government programs and varying levels of support from the authorities.

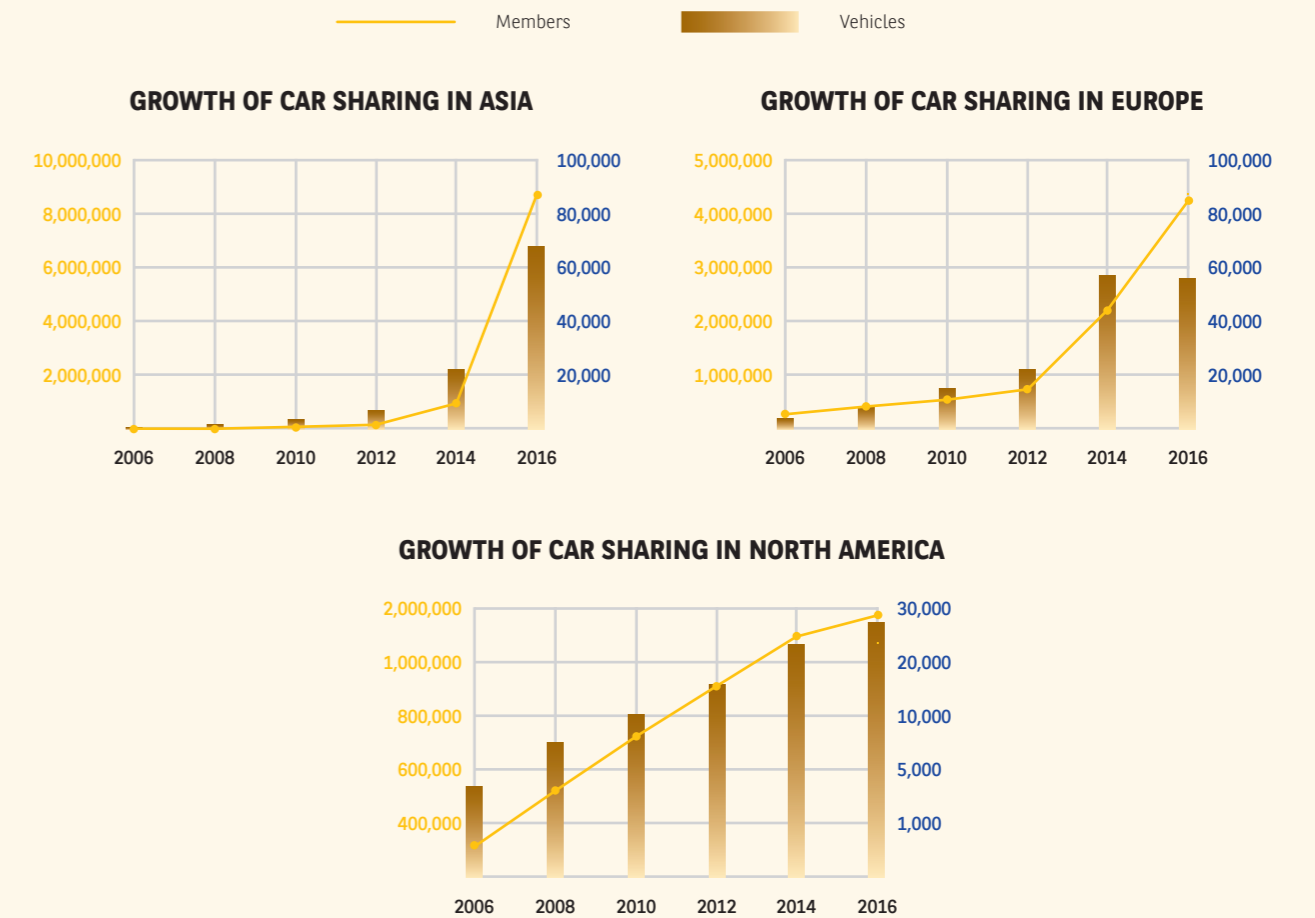

Source: Shaheen, Spring Carsharing Outlook, 2018
<https://escholarship.org/uc/item/49j961wb#main>

THE CAR: STILL A PROTECTED SPACE

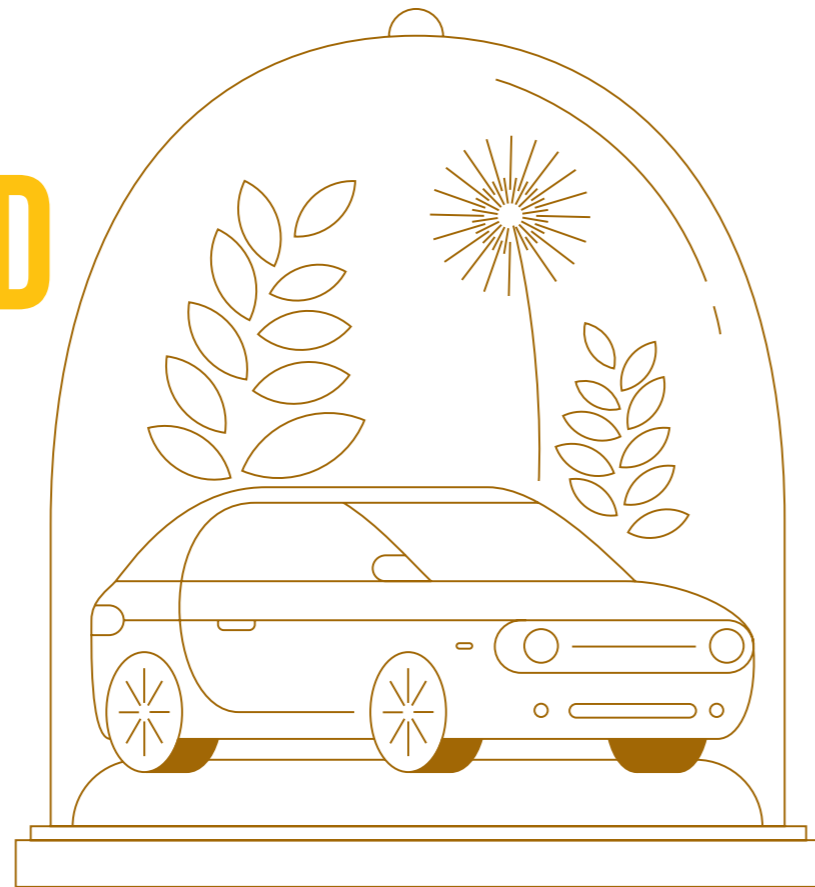

The potential to earn money is clearly the main reason why people engage in ride sharing and car sharing. And yet, the appeal of financial rewards does have its limits, not least the idea that cars are very much part of people's intimate space.

PRIVATE PROPERTY: DO NOT TOUCH

The main reason why motorists are not always keen to offer their car for rental is to avoid it being damaged. This is the case for 62% of respondents. For once, millennials and seniors, urbanites and rural dwellers are all on the same wavelength. But as previous L'Observatoire Cetelem surveys have already highlighted, cars have

an ever-increasing variety of uses and are becoming a sort of second home, a resolutely private space. The second reason given stems from a sense of ownership, which many are intent on safeguarding. 38% do not wish to rent out their vehicle because they want to be its only user (Fig. 38 and 39).

Fig. 38

What are your main reasons for not/no longer renting out your car?

In %, maximum of three answers

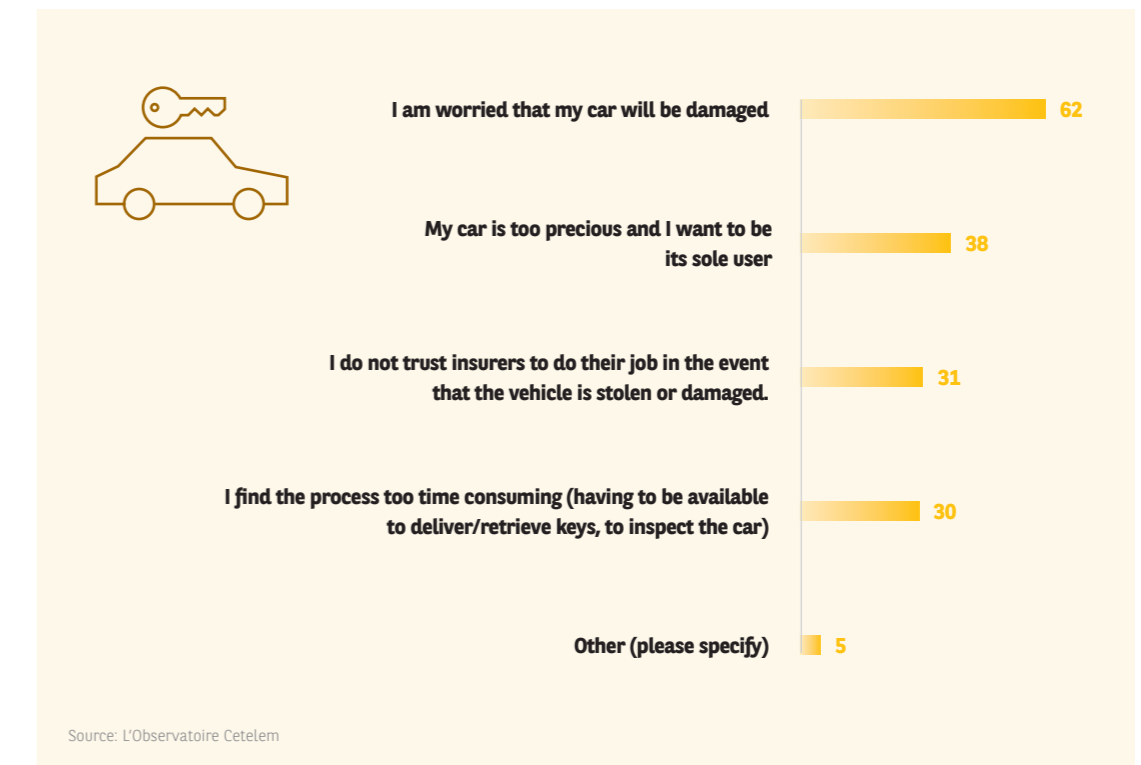

Fig. 39

What are your main reasons for not/no longer renting out your car?

In %, sum of "I am worried that my car will be damaged"



59%
EUROPE
AVERAGE



62%
WORLD
AVERAGE

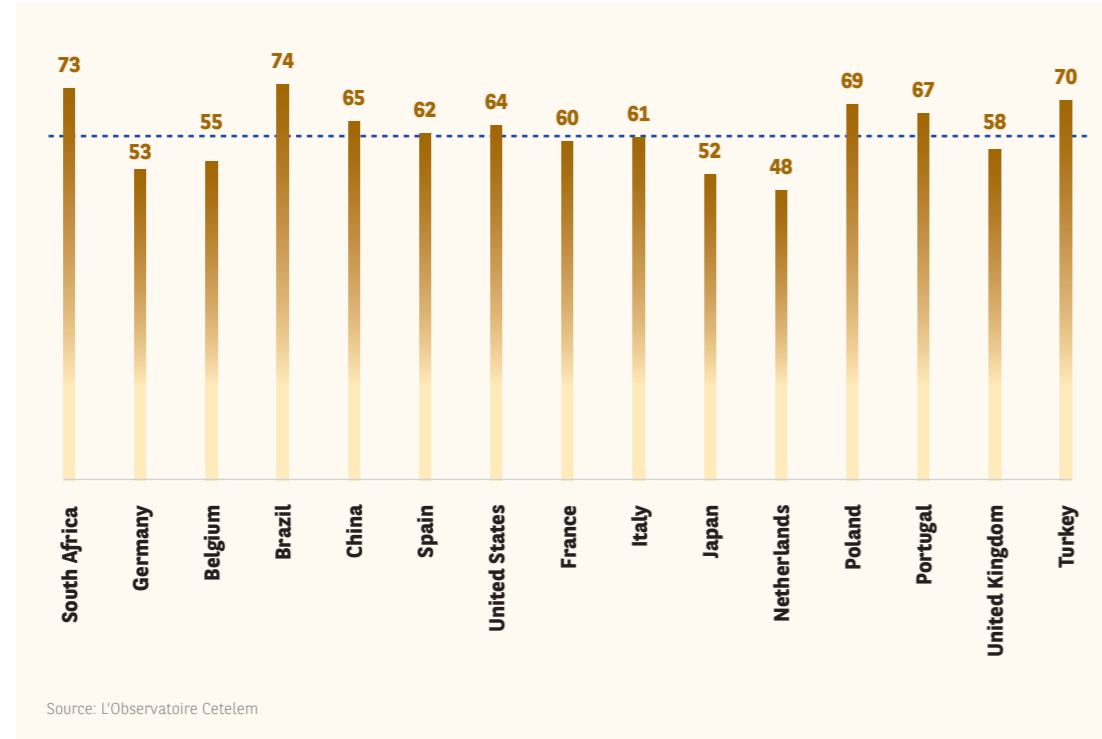

PROTECTING ONE'S PRIVACY: SENIORS ARE MORE MISTRUSTFUL

The desire to safeguard their privacy also conditions people's decision to forgo payment in exchange for allowing their private data to be recorded by sensors installed in vehicles. 57% consider that this would be an intrusion into their private life. 1 in 2 people fear that this data would be misappropriated and used for illegal purposes (Fig. 40). In both cases, seniors are somewhat more suspicious than millennials.

The fear that data may be used fraudulently is particularly strongly felt in China (70%). Yet the country is a paradise for ecosystems in which data is the new black gold, while also having the most digitalized vehicle purchasing systems. So is this a paradox or are their suspicions justified?

Fig. 40

What are your main reasons for not/no longer selling your personal data (via sensors installed in your car)?

In %, the colours represent the majority opinion in each country

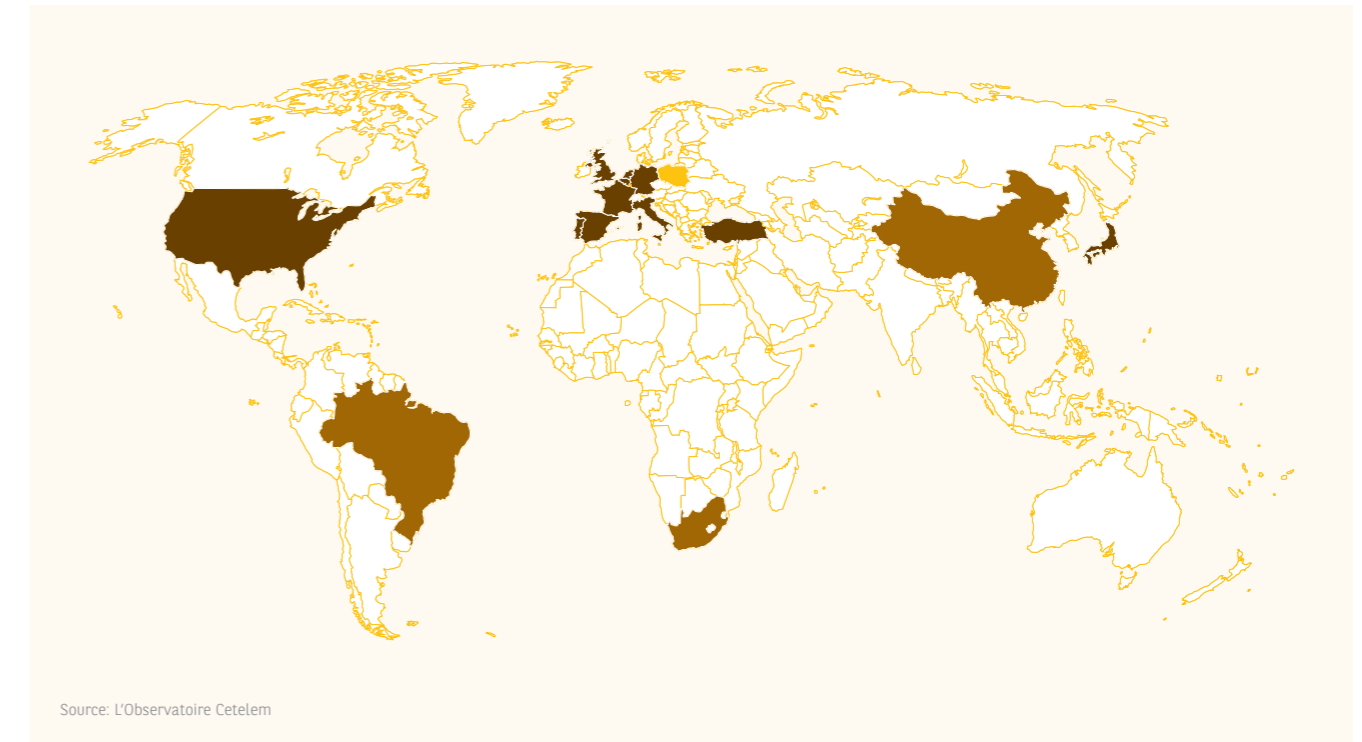

57%
I CONSIDER IT
AN INTRUSION
INTO MY PRIVATE LIFE

50%
I AM WORRIED
THAT MY PERSONAL DATA
WILL BE MISAPPROPRIATED /
USED ILLEGALLY

45%
I DON'T TRUST
THE COMPANIES
THAT COLLECT DATA

ADVERTISING: ZERO DISCRETION GUARANTEED

Advertising is another way to earn income with one's vehicle, but it is not popular with everyone. 1 in 2 motorists do not wish to turn their car into a sandwich board. Seniors are the most reluctant category, while the Germans and Brazilians are the least reticent in this area. It should be noted that 1 in 4 people ultimately consider the financial rewards to be insufficient, especially millennials (Fig. 41).

CONFIRMATION PENDING

Thus, from a marketing standpoint, should we view car sharing and ride sharing solutions as being purely for show? It is hard to ignore the fact that, beyond the emotional attachment people have to their cars, the constraints involved and the simple reality of life go a long way to explaining the confinement of car sharing and ride sharing to a relatively limited number of users. However, the influence of millennials and urban dwellers, who tend to be more favourable and open to these new forms of "automobility", means that hope remains that they will take off.

Fig. 41

What are your main reasons for not/no longer displaying advertising on your car?
In %, maximum of three answers

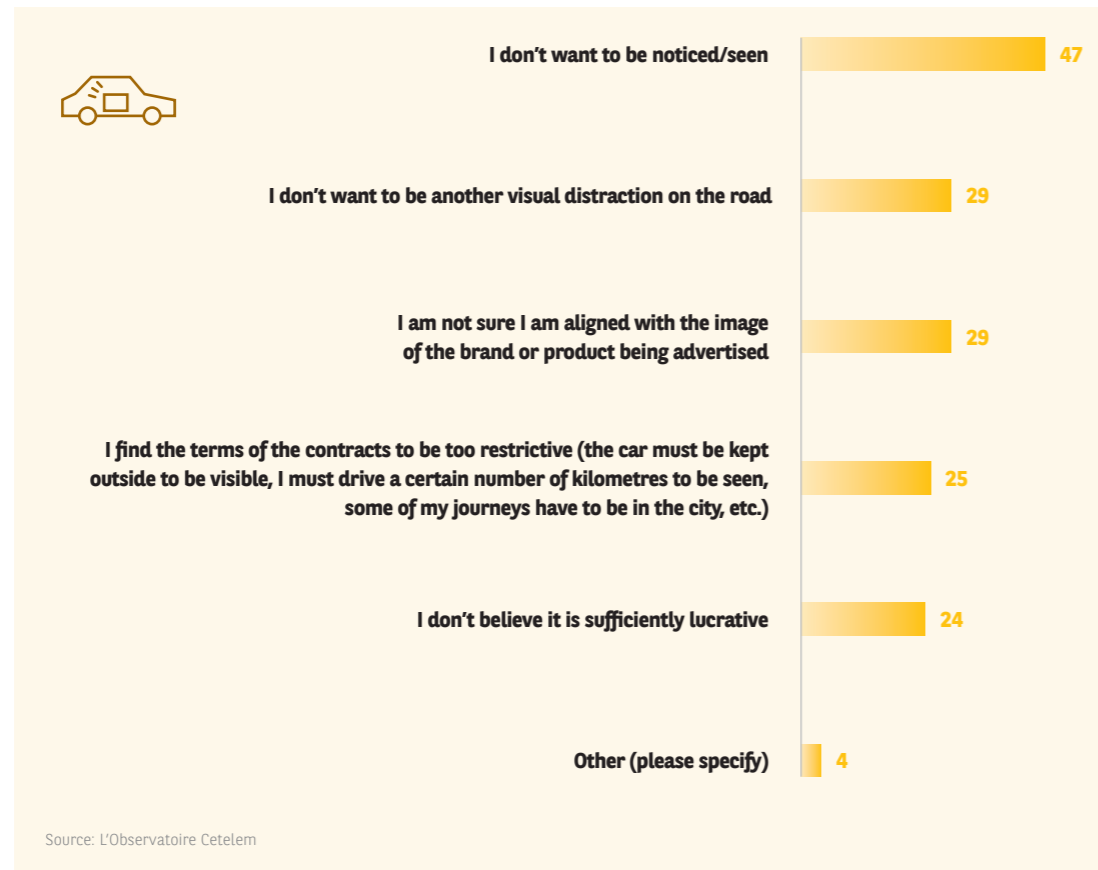

SUMMING UP

KEY FIGURES

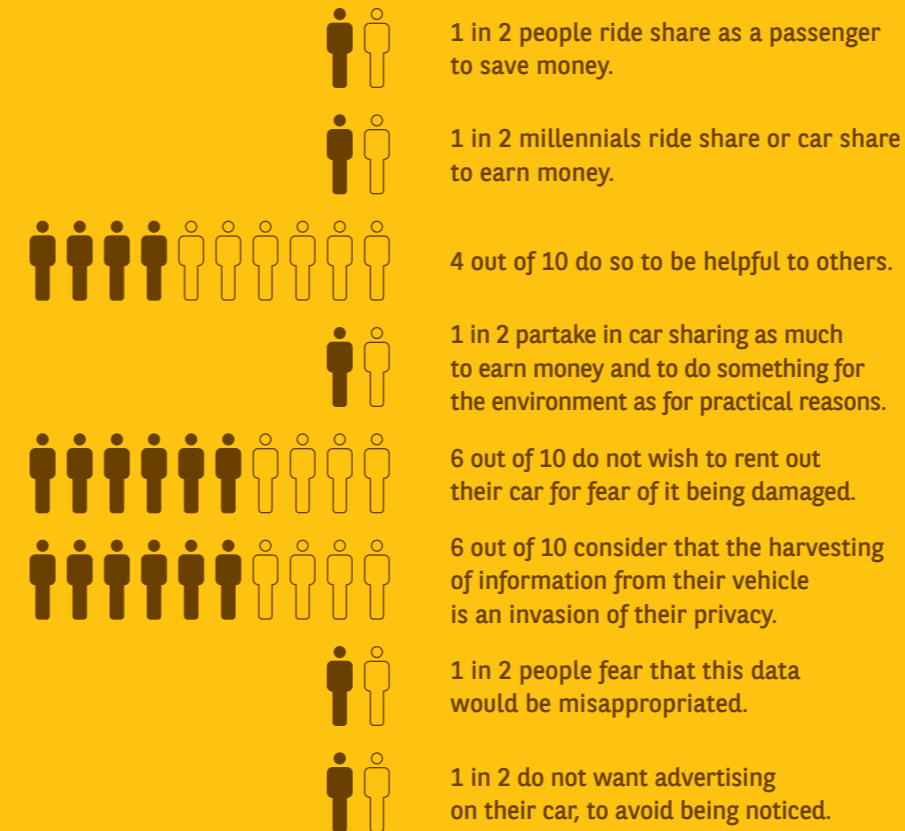

SCHISMS

- In emerging countries, ride sharing is chiefly a financially motivated practice.
- Seniors tend to choose ride sharing for environmental reasons.
- As for car sharing, seniors are driven more by environmental and practical motivations than by financial savings.
- Motorists in mature economies are much more reluctant than those in emerging countries to make their vehicles available for car sharing.
- Seniors are more concerned about protecting their privacy when it relates to their vehicle.

THERE ARE SOLUTIONS FOR THE FUTURE, BUT SCHISMS PERSIST

Cars raise questions, pose problems, appeal and attract, lend themselves to criticism and stimulate innovation. But one thing is certain: we have not finished talking about them. Or so motorists tell us. Indeed, while some do not necessarily see themselves owning a car, they cannot imagine a world without them. Will cars be able to survive in their current form? How important will new forms of "automobility" become around the world, within the different age groups, in cities and in rural areas?

To assess and monitor the roles and uses of cars, as well as access to vehicles, L'Observatoire Cetelem has put forward three exclusive indicators that track traditional and modern uses of cars.

CARS STILL HAVE A BRIGHT FUTURE

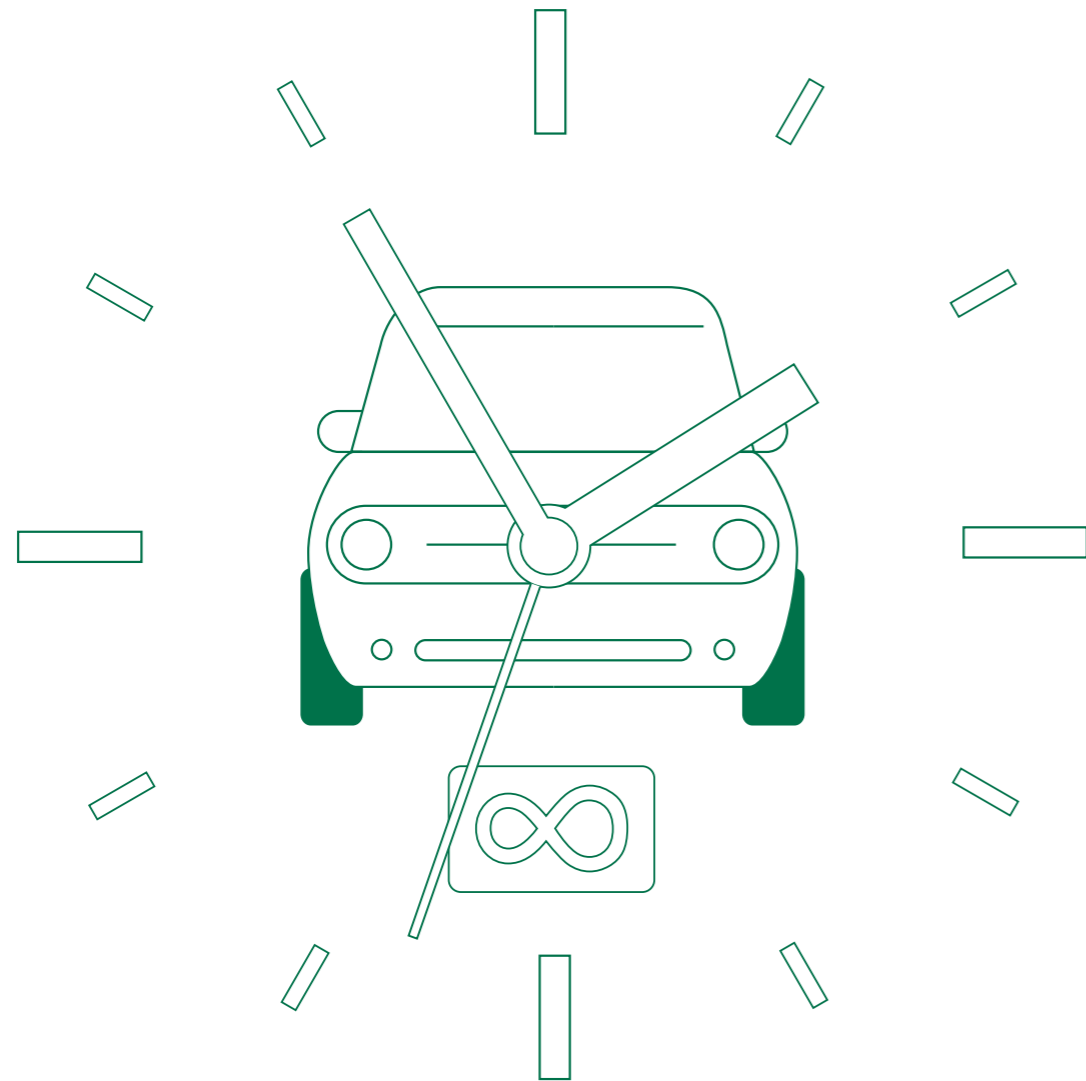

A SMOOTH ROAD TO THE FUTURE

Good news for manufacturers and retailers is the fact that 86% of those surveyed believe that people will still be buying and owning their own cars in 10 years' time. A quintet of countries state this loud and clear: Poland, South Africa, the United States, Brazil and the United Kingdom. A trio of countries seem less convinced: Japan, China and the Netherlands. In other good news, millennials are the most likely to be of this opinion, with China displaying the widest generation gap (84% of millennials vs. 60% of seniors).

The gap between urbanites and those who live in rural areas is significantly less marked (Fig. 42).

WHAT IF IT WERE FREE?

Monetizing one's navigation habits and data, but also agreeing to hear or see advertisements while in your car are possibilities that are more and more technically feasible, thanks to connected vehicles. These options are now being considered as ways of partially or completely offsetting vehicle costs. Could the "zero-dollar car" ever become a reality?

Fig. 42

In 10 years' time, do you think people will still buy/own cars?

In %, sum of "Yes" answers

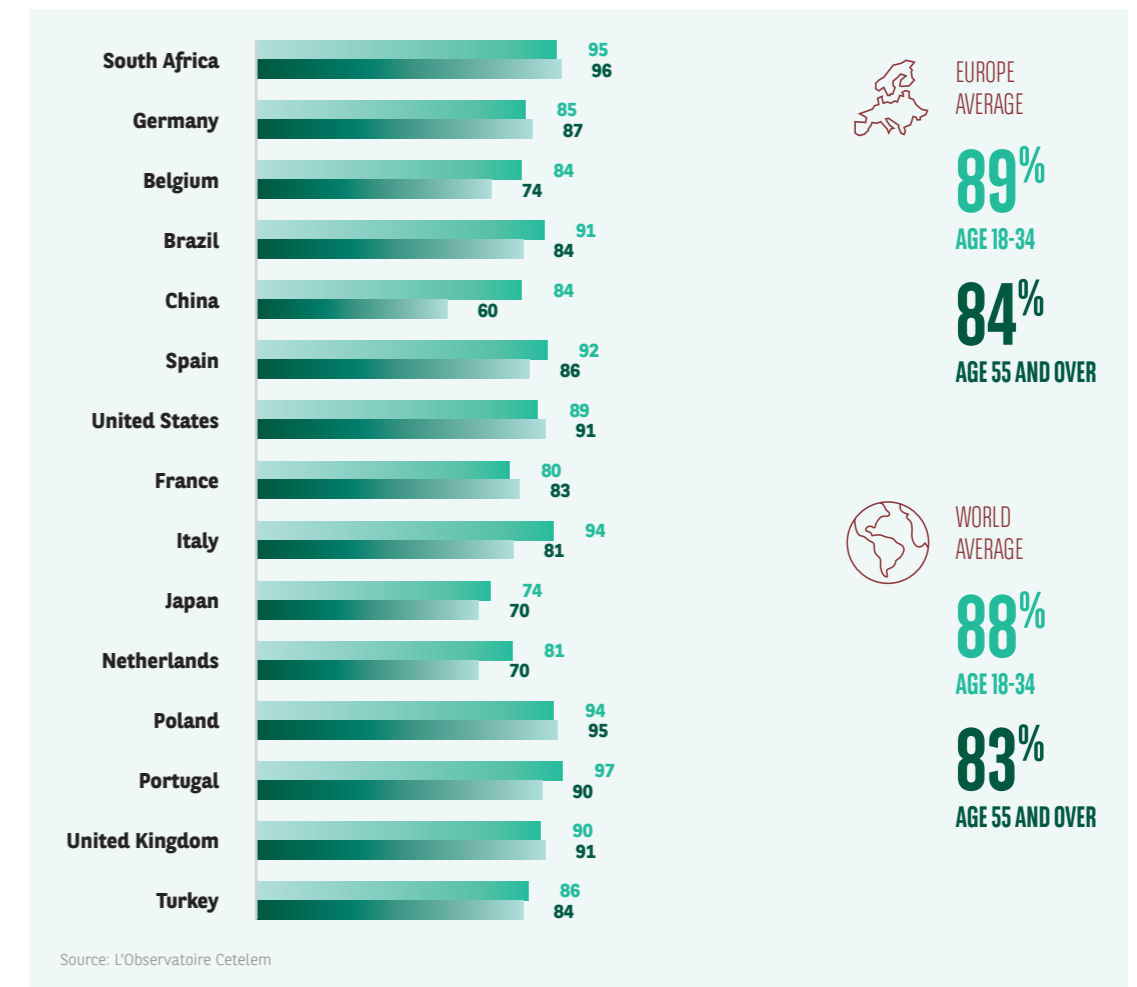

That is what many motorists want, imagining that they will one day be able to use a vehicle free of charge. 1 in 5 respondents believe this, growing to 1 in 2 in China. Europeans are the least convinced of the possibility, especially in Belgium, Germany and the Netherlands (Fig. 43). Less digitally savvy and less familiar with freemium services, seniors are the least likely to believe this could happen (12% on average). The high likelihood that they have owned a car for many years, at a cost that they deem too high for the idea to be realistic, probably explains this low score.

Once again, the Germans and Belgians are under no illusion about this. We should also not forget that this study has shown millennials to be very sensitive to the issue of motoring budgets. It makes perfect sense that they should be more likely than their elders to imagine that motoring will one day be free. Chinese millennials again stand apart, with two-thirds of them believing that this could become a reality. The Brazilians, who are also big fans of digital, are not too far behind.

Fig. 43

Do you think that we will one day be able to use cars free of charge?

In %, sum of "Yes" answers

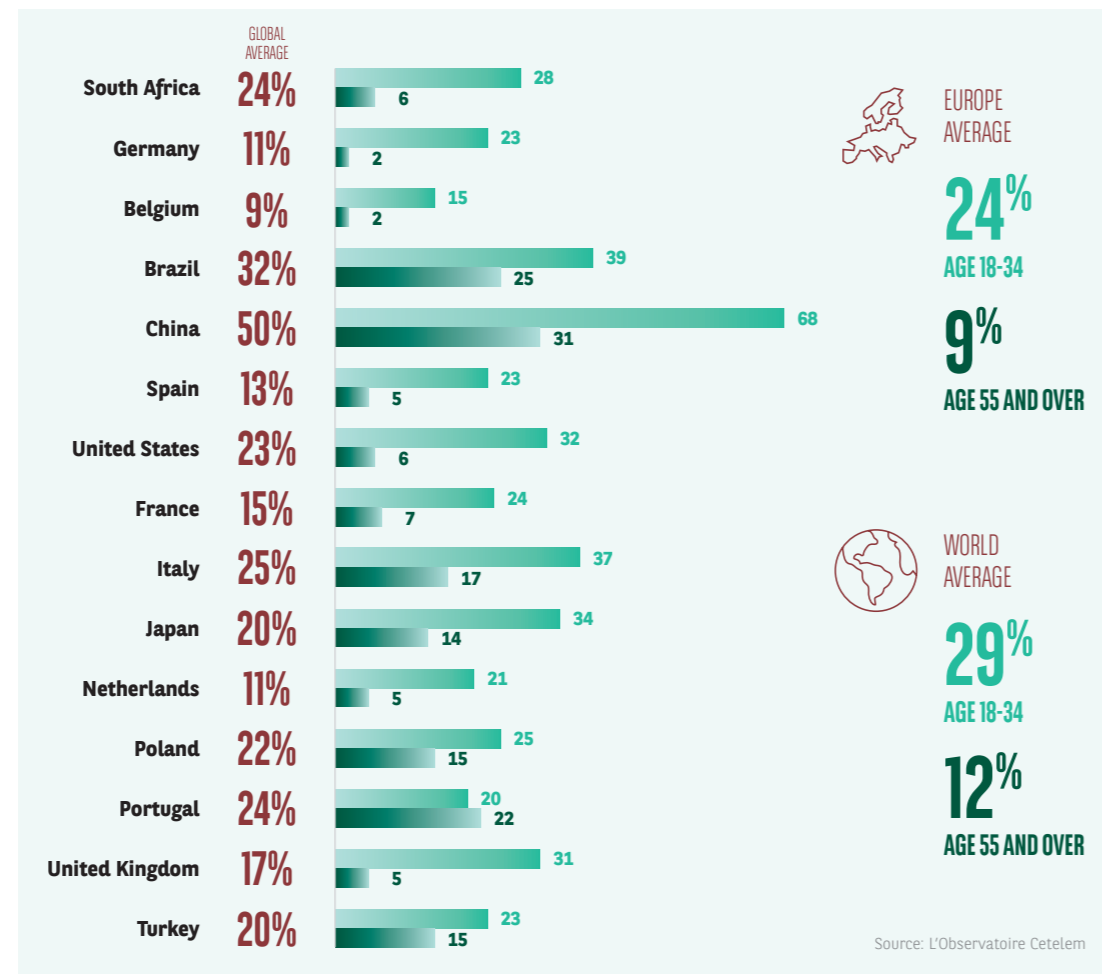

China, home of the car of the future

China, the world's leading market after 15 years of continuous growth, has seen car sales drop significantly for more than a year now. Could this be a sign of a decline? Not necessarily. At least if we take into account the nature of this market and how the sector is being modernised. The way in which the country is organised economically and politically has also enabled the implementation of commercial measures and principles that are causing this same market to shift. Faced with the problem of air quality, electric car use is being encouraged there more than anywhere else, both through the subsidies granted for such vehicles and restrictive measures to limit sales of petrol and diesel vehicles. Another crucial parameter is the fact that, if we exclude GAFA, China and its BATX (Baidu, Alibaba, Tencent and Xiaomi) can be described as the world's leading technological power, particularly in terms of artificial intelligence and the advanced commercial use of telephony. Today, the Chinese can choose, test drive, order and pay for a vehicle with their smartphone and could soon see the widespread appearance of autonomous vehicles, of which China is also a pioneer. Such advances have been made possible by China's appetite for technology and its state-led ecosystem approach.

HOW TO EARN MONEY WITH YOUR CAR TOMORROW

Because potential free access to cars will not become a reality in the immediate future, motorists are prepared to consider solutions that would enable them to earn money with their car. The first of these is advertising, which 1 in 3 motorists would accept more or less across the panel of countries, with the exception of Japan, which is more timid in embracing the practice (13%). Ride sharing, over short or long distances, also has many potential fans (29% and 26%), followed closely by the idea of renting out one's parking space (25%). As we have seen many times when it comes to economic issues, South Africa, China, Turkey and Brazil seem the keenest on this solution. Renting one's car to a company or a private individual and selling personal data relating to car use are seen as less attractive. Nonetheless, 1 in 5 motorists say that they are prepared to grasp this new opportunity to earn money with their car (Fig. 44).

Fig. 44

To earn money thanks to your car, would you be willing to...

In %, sum of "You have never done so, but would be prepared to try"

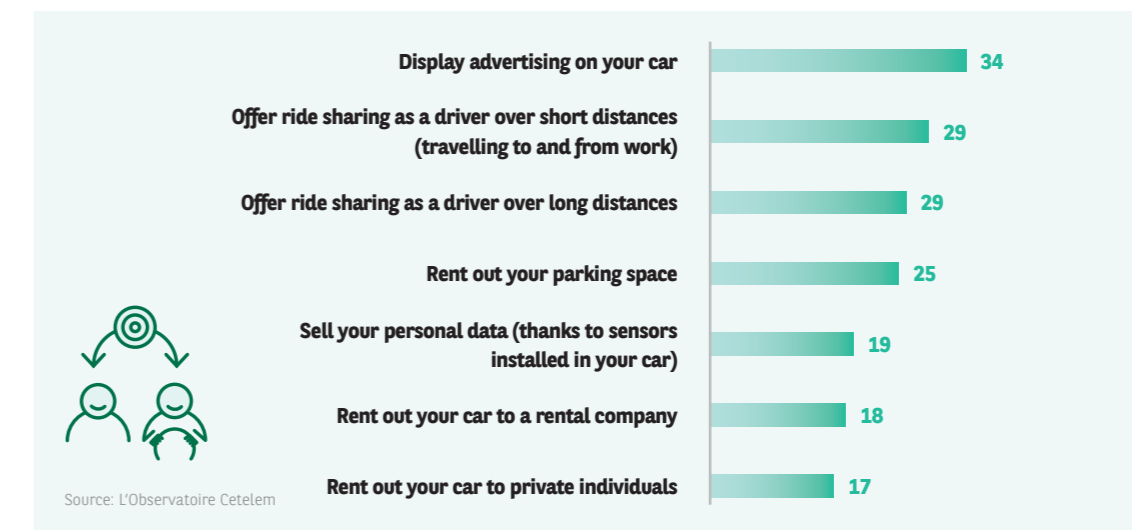

THE FUTURE OF MOTORING IS ON TRACK

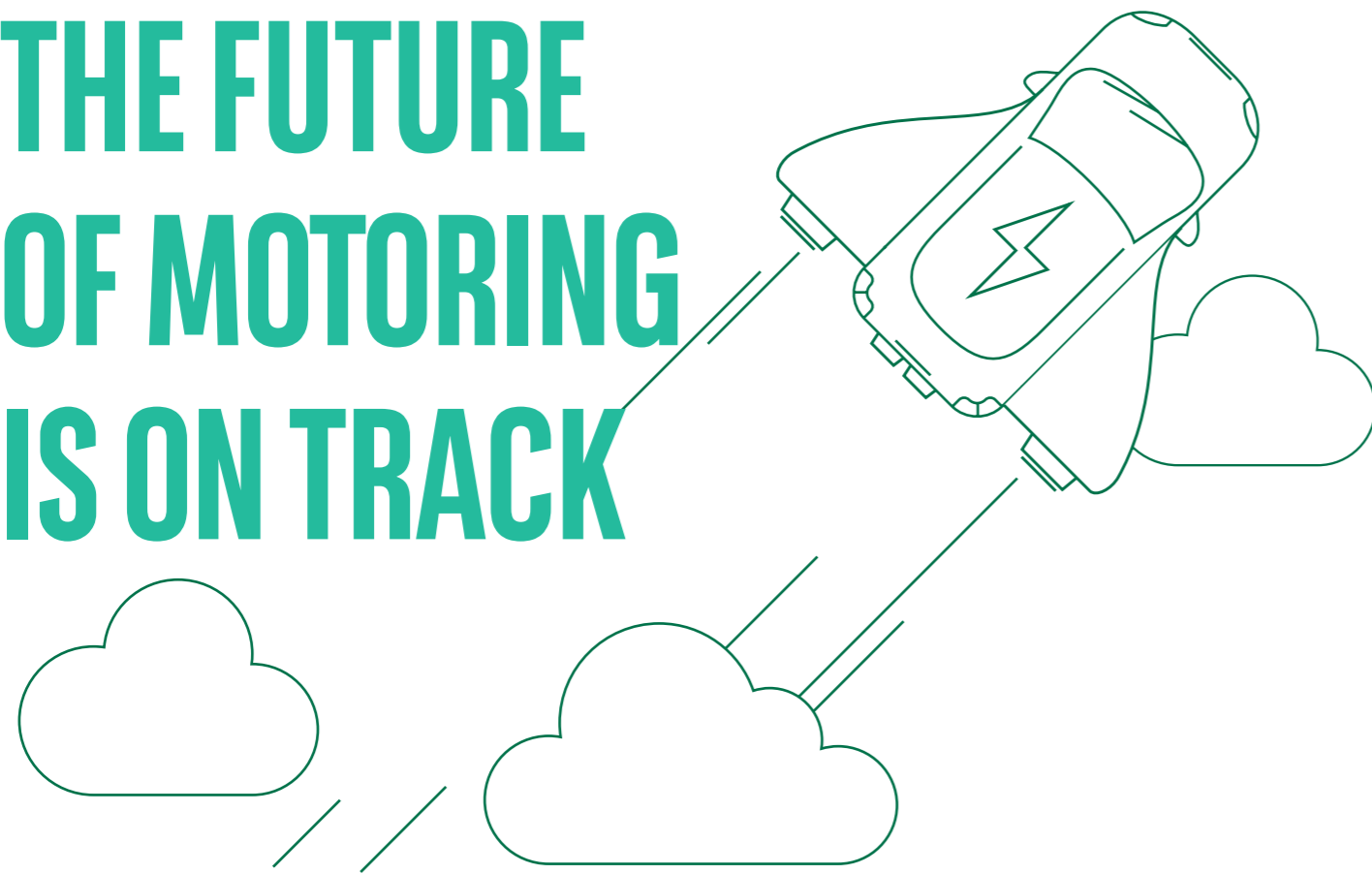

With an eye on the future and to contribute to a better understanding of what awaits the motoring world, L'Observatoire Cetelem set up three indicators to compare the traditional uses of cars with those that are emerging today, but more importantly to assess their development potential. These three composite indicators were defined based on the variables contained in the questionnaire used as a basis for this survey.

Nature and composition of the indicators

Car Use Now assesses the degree to which the traditional model of car ownership and use is embraced, on a scale of 1 to 10. It is made up of variables relating to motorization, use and people's attachment to their car and the freedom it confers. The higher the score, the more likely it is that cars will be seen as useful and used in the traditional way.

- Number of vehicles per household
- Kilometres travelled per weekday
- Changes in car use
- Emotional attachment to one's vehicle
- Importance placed on the freedom provided by car ownership

Car Use New assesses the actual and current level of adoption of new ways of accessing and using cars, as well as ways of saving and earning money with one's vehicle, on a scale of 1 to 10. The higher the score, the more common the use of new forms of "automobility".

- Frequency with which new travel solutions are used (car sharing, ride sharing, etc.)
- Membership of a ride sharing or car sharing scheme
- Practices that reduce the cost of car ownership

Car Use Next uses the same indicators as Car Use New, but focuses not only on those who currently take advantage of new practices, but also on those who say they are interested and plan to use them one day. The higher the score, the more likely it is that these uses will become more widespread.

- Frequency with which new travel solutions are used (car sharing, ride sharing, etc.)
- Membership of a ride sharing or car sharing scheme
- Practices that reduce the cost of car ownership

INDICATORS THAT POINT TO SCHISMS IN THE AUTOMOTIVE WORLD

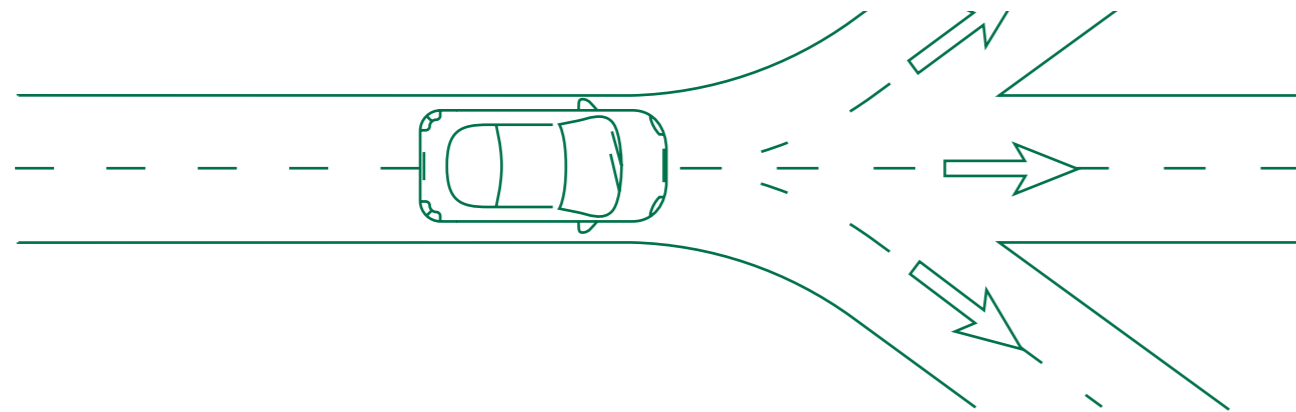

A CLEAR DICHOTOMY BETWEEN WESTERN AND EMERGING COUNTRIES

Regarding the Car Use Now indicator, traditional car use is holding up rather well in Western nations. Italy, Poland, France, Portugal, Spain and the United States post indicators that are above or equal to the average. In last place in the ranking, China scores almost half as low as Italy, which comes top (3.3 vs. 6.2). It is worth noting the lowly positions in the ranking of Germany and the United Kingdom, despite their longstanding automotive traditions. A completely different picture appears if we look at the indicators relating to the current or potential adoption of new automobility solutions, with the emerging countries leading the way. By posting the highest scores for the Car Use New and Car Use Next indicators, China confirms

its status as a laboratory for the future of motoring (2.9 and 3.5). It is also no surprise, as we have consistently seen throughout the survey, that Turkey, Brazil and South Africa are not too far behind, with very similar scores. Less predictable is the fact that the United States is the next country in the ranking behind this quartet. Although they live in a country of wide open spaces and mobility *par excellence*, Americans demonstrate their ability to adapt to this changing product and adjust their way of life accordingly, without necessarily being willing to give it up. It is interesting to see France, Italy, Belgium and Germany still flying the flag for the old continent's traditional motoring values. These countries are rooted to the bottom of the rankings in terms of these two indicators, pointing to a certain reluctance to accept change.

Fig. 45 Cetelem Car Use indicator



YOUNG PEOPLE AND URBANITES TAKE THE LEAD

CARS ARE TODAY ESSENTIAL IN RURAL AREAS

Throughout this survey, we have identified non-geographical divides both between millennials and seniors, and between the inhabitants of large cities and rural dwellers. The three indicators used highlight these schisms.

The Car Use Now indicator is highest in the least densely populated regions, confirming the importance of cars for those living in rural areas far from urban centres, where alternatives to cars are the rarest. The results shift gradually as we head towards cities with more than 1 million inhabitants, which post the lowest scores. Indeed, these urban areas provide more competition for cars in both economic and practical terms, thanks to public transport and so-called "active" modes of transport (walking, cycling, etc.). Urbanites not only consider cars less essential, but even inappropriate in many cases. If we compare the generations, ignoring divergences between types of residential area, the scores do not highlight any significant differences when it comes to traditional car use.

THE FUTURE OF NEW MOBILITY SOLUTIONS IN URBAN AREAS WILL BE FUELED BY THE YOUNGER GENERATIONS

It makes perfect sense that the Car Use New and Car Use Next indicators, which reflect the emergence of new mobility solutions, should post the highest scores in large cities. And yet, these figures fail to reach the levels attained by Car Use Now. However, setting generational differences aside, the difference between the smallest and largest cities is often two fold.

And on the topic of age, seniors post significantly lower scores for Car Use New and Car Use Next. Given that they are more comfortable with digital booking platforms and often face greater financial constraints, millennials are quicker to adopt new ways of using and paying for car-related services, and even more declare that they are doing so.

It is interesting to correlate these results with those obtained regarding people's technophilia and their adoption of innovations. The percentage of people under 55 who are willing to immediately try a new product, service or concept store is twice as high as the proportion of over-55s. The same is true of peer-to-peer services.

Tab. 1

Car Use Now

Traditional car ownership and use

	Age 18-34	Age 35-54	Age 55 and over
In a city with more than 1,000,000 inhabitants	4	4,4	3,6
In a city with between 100,001 and 1,000,000 inhabitants	4,3	4,5	4,2
In a city with between 20,000 and 100,000 inhabitants	4,5	4,8	4,7
In a rural area / in a city with fewer than 20,000 inhabitants	5,1	5,5	5,4

Tab. 2

Car Use New

Stated adoption of new automobility solutions and ways of accessing cars

	Age 18-34	Age 35-54	Age 55 and over
In a city with more than 1,000,000 inhabitants	2,8	2	1,6
In a city with between 100,001 and 1,000,000 inhabitants	2,3	1,7	1,4
In a city with between 20,000 and 100,000 inhabitants	2,2	1,4	1,2
In a rural area / in a city with fewer than 20,000 inhabitants	1,7	1	1,1

Tab. 3

Car Use Next

Stated intention to adopt new automobility solutions and ways of accessing cars

	Age 18-34	Age 35-54	Age 55 and over
In a city with more than 1,000,000 inhabitants	3,5	2,8	2,1
In a city with between 100,001 and 1,000,000 inhabitants	3,1	2,4	1,9
In a city with between 20,000 and 100,000 inhabitants	3,1	2,2	1,8
In a rural area / in a city with fewer than 20,000 inhabitants	2,5	1,8	1,7

Tab. 4 and 5

Percentage of respondents who declare themselves to be among the first wave of people to try a new product, service or concept store

In %

	Age under 55	Age 55 and over
City with fewer than 1,000,000 inhabitants	51%	33%
City with more than 1,000,000 inhabitants	59%	34%

Percentage of respondents who like to exchange items with or buy them from other private individuals

	Age under 55	Age 55 and over
Ville de moins de 1,000,000 d'habitants	54%	36%
Ville de plus de 1,000,000 d'habitants	58%	30%

FUTURE AUTOMOBILITY: A CHASM BETWEEN CITIES AND RURAL AREAS THAT WILL BE HARD TO BRIDGE

It is reasonable to project that a generational effect will lead to current and future innovations spreading far and wide, with future seniors retaining the habits of their youth as they age, not least the latest ways in which cars can be used.

However, the indicators relating to future uses (Car Use Next) in rural and sparsely populated areas do not reach the levels observed in cities. This clearly points to the limited degree to which new forms of automobility can develop outside megacities.

SUMMING UP

KEY FIGURES

Almost 9 out of 10 people think that we will still be buying cars in 10 years' time.



2 out of 10 people believe that cars will one day be free.

SCHISMS

- Millennials are more likely than seniors to believe that we will still be buying cars in 10 years' time.
- Very few seniors believe that cars will one day be free.
- Motorists in emerging countries are the most likely to want to earn money thanks to their cars.
- Unsurprisingly, traditional car ownership and use is more popular in rural and sparsely populated areas.
- The generational divide is not clear when it comes to the old-fashioned approach to motoring.
- The recent trend of renting, sharing and monetizing cars is very much the preserve of those who live in cities, major conurbations in particular, and young people, especially the youngest.

KEY FIGURES

THE NEW PASSENGER CAR (NPC) MARKET

	2017	2018	2019*	2019/2018 variation	2020*	2020/2019 variation
France	2,110,748	2,173,481	2,170,000	-0,2%	2,100,000	-3,2%
Italy	1,970,497	1,910,025	1,870,000	-2,1%	1,830,000	-2,1%
Spain	1,234,931	1,321,438	1,225,000	-7,3%	1,200,000	-2,0%
Portugal	222,134	228,327	217,000	-5,0%	208,000	-4,1%
Belgium – Luxembourg	599,333	602,418	585,000	-2,9%	573,000	-2,1%
United Kingdom	2,540,617	2,367,147	2,305,000	-2,6%	2,190,000	-5,0%
Germany	3,441,261	3,435,778	3,525,000	2,6%	3,454,500	-2,0%
Netherlands	414,538	443,531	408,000	-8,0%	400,000	-2,0%
Poland	484,190	531,889	543,000	2,1%	530,000	-2,4%
Czech Republic	271,595	261,437	240,000	-8,2%	230,000	-4,2%
Slovakia	95,976	98,080	99,000	0,9%	97,000	-2,0%
Hungary	116,265	136,601	150,000	9,8%	140,000	-6,7%
13-country total	13,502,085	13,510,152	13,337,000	-1,3%	12,952,500	-2,9%
Europe 27 + EFTA ⁽¹⁾	15,606,865	15,626,509	15,390,000	-1,5%	14,900,000	-3,2%
Japan	4,386,378	4,391,160	4,480,000	2,0%	4,480,000	0,0%
United States	17,239,892	17,337,214	17,075,000	-1,5%	16,700,000	-2,2%
China	24,950,000	23,709,782	21,340,000	-10,0%	22,000,000	3,1%
Brazil	1,840,000	2,101,884	2,250,000	7,0%	2,400,000	6,7%
Turkey	735,000	486,321	317,000	-34,8%	320,000	0,9%
Total	64,758,135	63,652,870	60,852,000	-4,4%	60,800,000	-0,1%

* estimates and forecasts from l'Observatoire Cetelem de l'Automobile

⁽¹⁾ EU 27 (excl. Malta and Cyprus) + Norway, Switzerland and Iceland

LIGHT VEHICLE (LV) MARKET*

	2017	2018	2019*	2019/2018 variation	2020*	2020/2019 variation
World* in millions	94	94	90	-4,3%	91	0,6%

* Estimates and forecasts from l'Observatoire Cetelem de l'Automobile

Light vehicles = passenger cars + light commercial vehicles

NEW PASSENGER CAR REGISTRATIONS IN EUROPE* IN 2018

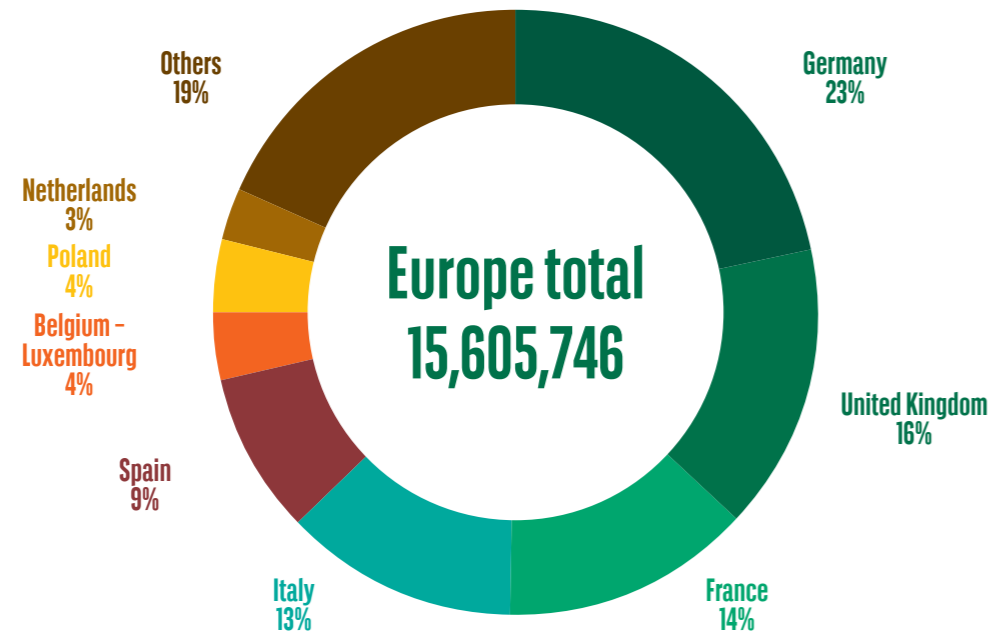

* EU 27 (excl. Malta and Cyprus) + Norway, Switzerland and Iceland
Sources: ACEA

HOUSEHOLD PURCHASE RATE - 2019 PROJECTIONS

The calculation is strictly based on car registrations for private use.

	Total NPC registrations	Private share	Company share	Private registrations	Number of households 2017	Household purchase rate
France	2,170,000	45%	55%	976,500	29,314,400	3,3%
Italy	1,870,000	56%	45%	1,037,850	25,864,700	4,0%
Spain	1,225,000	49%	51%	599,025	18,512,500	3,2%
Germany	3,525,000	35%	65%	1,233,750	40,722,600	3,0%
United Kingdom	2,305,000	42%	58%	965,795	28,822,300	3,4%
Total	11,095,000	43%	57%	4,812,920	143,236,500	3,4%

Sources: CCFA, ANFAC, ANFIA, KBA, SMMT

LEADING BRANDS IN EUROPE 2019

	Market share 9 months 2019	Market share 9 months 2018	Variation 2019 vs. 2018		Market share 9 months 2019	Market share 9 months 2018	Variation 2019 vs. 2018
VOLKSWAGEN	11,0%	11,3%	-4,0%	SEAT	3,3%	3,0%	9,3%
RENAULT	6,8%	7,3%	-8,6%	VOLVO CAR CORP.	2,0%	1,9%	5,2%
FORD	6,2%	6,3%	-3,5%	MINI	1,4%	1,3%	2,2%
PEUGEOT	6,2%	6,2%	-1,7%	JEEP	1,1%	1,1%	0,7%
OPEL / VAUXHALL	5,7%	5,8%	-2,4%	HONDA	0,8%	0,9%	-13,1%
MERCEDES	5,5%	5,2%	4,1%	LAND ROVER	1,0%	1,0%	-0,5%
AUDI	4,8%	5,0%	-5,0%	SMART	0,7%	0,6%	5,9%
BMW	5,0%	4,9%	-0,4%	ALFA ROMEO	0,3%	0,6%	-42,4%
FIAT	4,3%	4,8%	-11,0%	PORSCHE	0,4%	0,5%	-10,0%
SKODA	4,7%	4,5%	2,9%	JAGUAR	0,5%	0,5%	-6,0%
TOYOTA	4,7%	4,5%	1,6%	LANCIA / CHRYSLER	0,4%	0,3%	29,2%
CITROEN	4,2%	3,9%	6,4%	DS	0,3%	0,3%	-1,3%
HYUNDAI	3,5%	3,5%	0,3%	LEXUS	0,3%	0,3%	16,6%
DACIA	3,8%	3,3%	11,4%	LADA	0,0%	0,0%	-7,8%
NISSAN	2,5%	3,3%	-25,4%	ALPINE	0,0%	0,0%	172,5%
KIA	3,2%	3,2%	1,1%				

Source: ACEA

TOP 3 BRANDS IN EUROPE IN 2019

2019 market share (9 months)

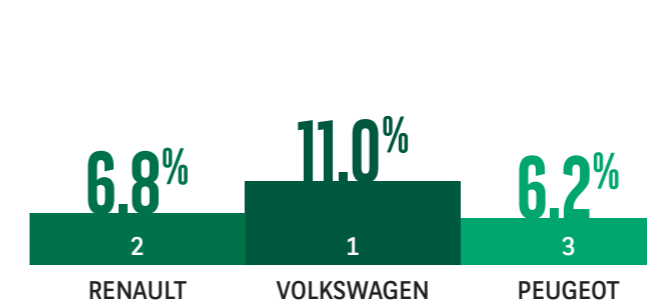

Source: ACEA

TOP 3 GROUPS IN EUROPE IN 2019

2019 market share (9 months)

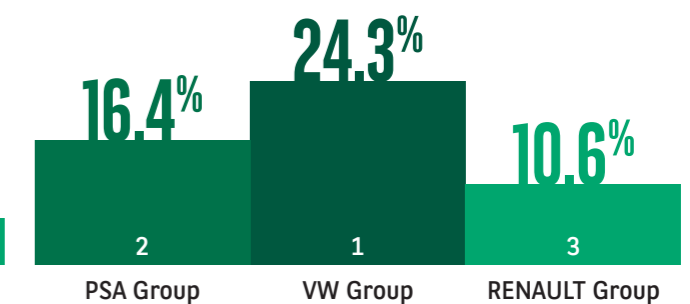

Source: ACEA

THE NEW-VEHICLE MARKET IN FRANCE

In number of registrations

	2013	2014	2015	2016	2017	2018	2019*
NPC – New passenger car	1,790,456	1,795,885	1,917,226	2,015,177	2,110,748	2,173,518	2,170,000
LCV – Light commercial vehicle	367,334	372,074	379,424	397,085	438,645	459,038	483,000

* Estimates and forecasts from L'Observatoire Cetelem de l'Automobile
Source: C-Ways according to SIV

STRUCTURE OF THE NEW-PASSENGER CAR MARKET IN FRANCE

In %

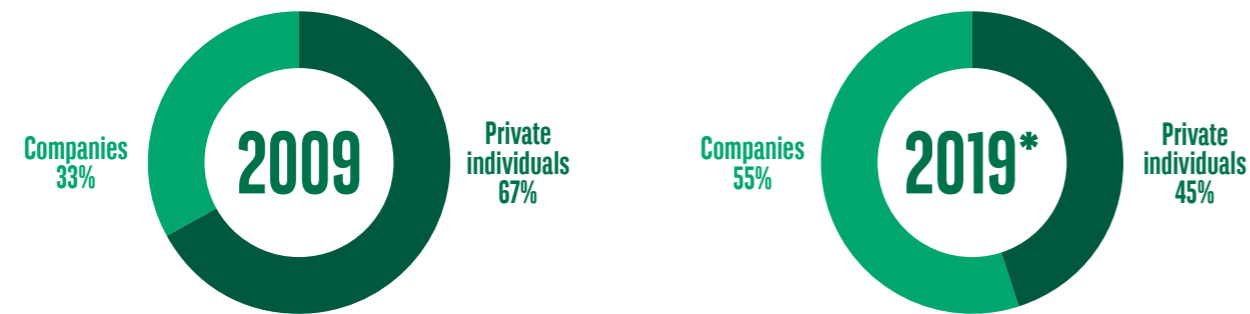

* Estimates and forecasts from L'Observatoire Cetelem de l'Automobile
Source: C-Ways according to SIV

NPC MARKET SHARE OF FRENCH BRANDS* IN FRANCE

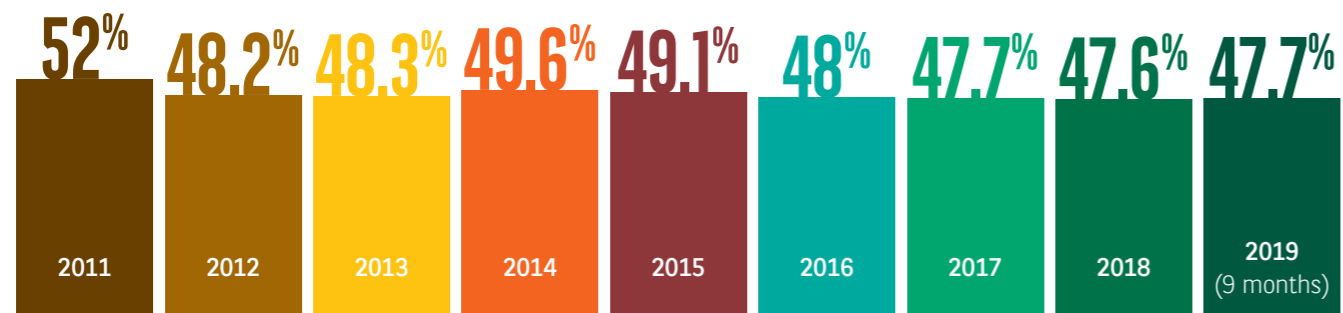

* French brands: Citroen, Peugeot, DS and Renault
Source: CCFA

THE USED-CAR MARKET IN FRANCE IN 2019

In number of registrations

	2019 (10 months)
UVs* less than one year old	503,337
UVs* 1-5 years old	1,312,322
UVs* over 5 years old	3,081,722
Total UVs*	4,897,381

* Used vehicles
Source: C-Ways according to SIV

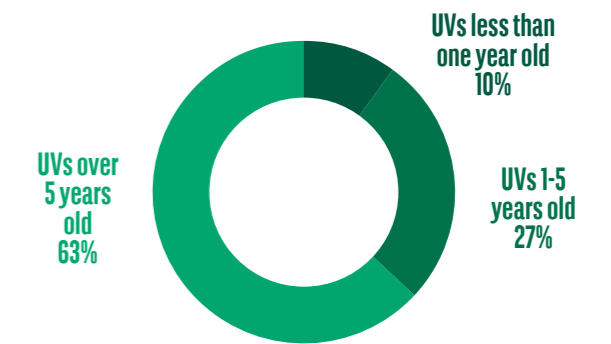

CONCLUSION

THE AUTOMOTIVE WORLD IS DIVIDED. FOR SOME IT WILL REMAIN SO.

While many are still as keen to acquire a car, which remains synonymous with freedom from the constraints of space and time, others hold the automobile responsible for all kinds of environmental evils, to the point where it is being driven out of certain public spaces.

But divides within countries have also opened. The ability to do without a car is a luxury, one enjoyed only by urbanites who have everything at their fingertips and a range of transport options available to them. Living without a car is, at best, purgatory for young people whose circumstances and income are yet to be able to offset its cost and, at worst, an unimaginable nightmare for peri-urban and rural populations who are miles from everything, especially public transport alternatives. With all the stumbling blocks they face, it is no coincidence that the rural young are known as those the car left behind.

The irony of the situation is that alternative and modern ways of using cars can only develop where they are least needed: in cities. The population size and density required for new sharing-based solutions to be economically viable are not compatible with the wide-open spaces and low human density of rural areas.

The latest standards and technical advances are helping to limit pollution from vehicles and reduce their contribution to the environmental crisis. Other more or less proven innovations and solutions may go some way to making motoring more affordable for the younger generations. But it seems that the gap between urban and rural perceptions of the automobile will remain open and the source of contention for a long time to come.

COUNTRY FACT SHEETS

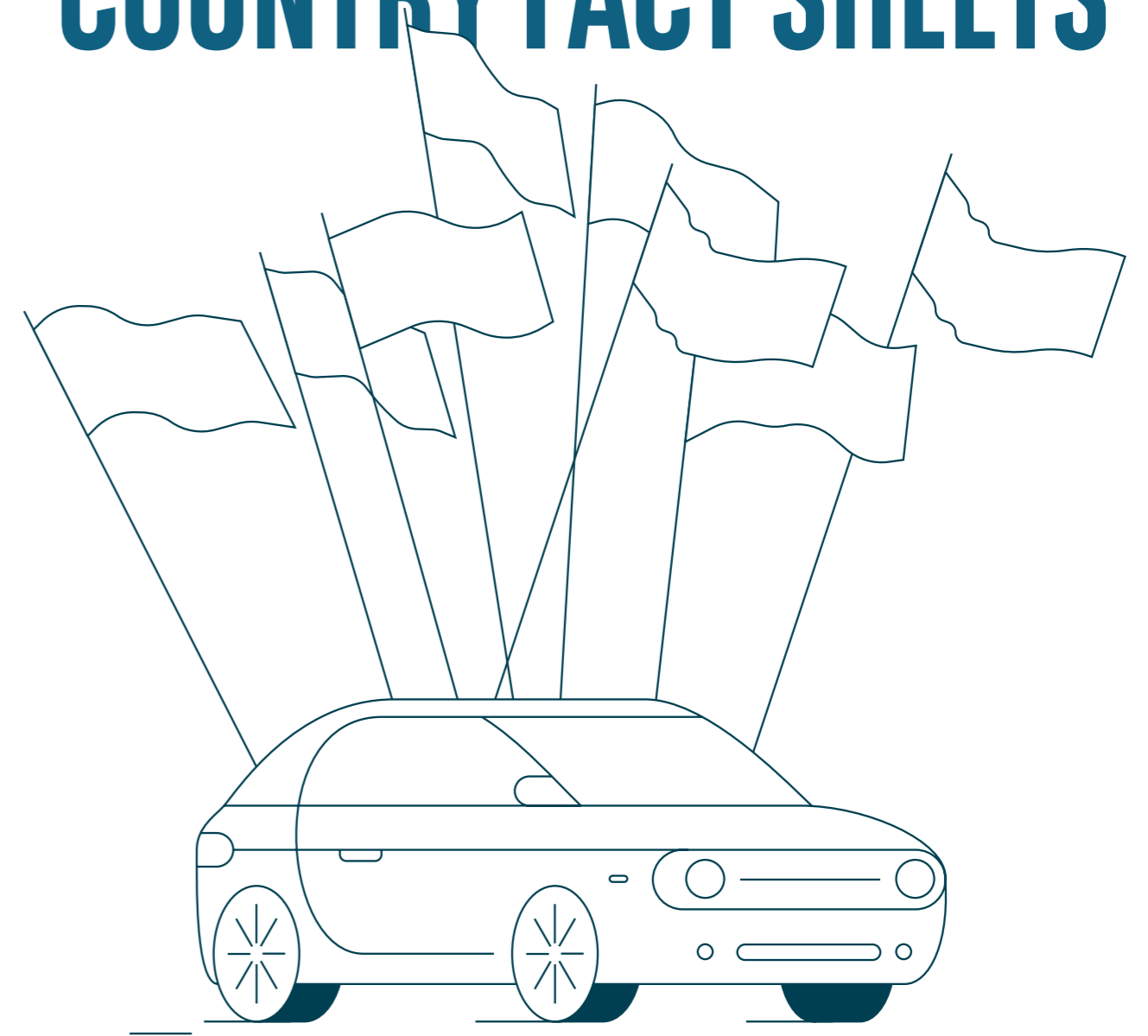



South Africa

The South Africans and their cars

CAR USE IN SOUTH AFRICA

The automotive sector in South Africa displays a great deal of development potential. Indeed, its motorization rate is one of the lowest in the panel. And yet, the market is not particularly buoyant at the moment. This is despite everything appearing to be in place to enable this potential to be fulfilled: a quality road network, a modern industrial infrastructure and even car assembly plants. And, not least, a fondness for cars on the part of South Africans that is higher than the world average and a low proportion of people who would consider living without a car.

- **Market forecast** (New passenger vehicles in millions): **2018: 0,37 | 2019: 0,35 | 2020: 0,36**
- **2018 motorization rate:** **176 vehicles** per 1,000 inhabitants (world: 515)
- **84% are attached to their car (world: 80%)**
- **54% state that they are prepared to not/no longer own a car** (world: 58%), broken down as follows:

	€		
Inhabitants	Income	Gender	Age
< 100,000 55%	Low 61%	Men 53%	< 55 years 54%
> 100,000 53%	High 47%	Women 55%	> 55 years 48%

THE SOUTH AFRICANS AND NEW AUTOMOBILITY SOLUTIONS

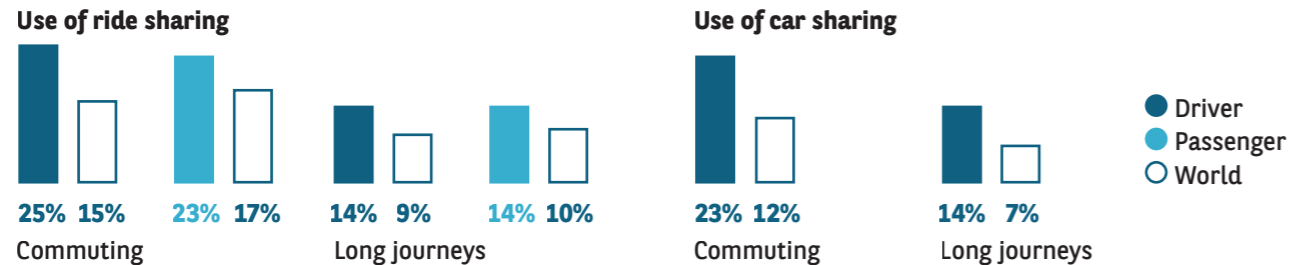

CETELEM INDICATOR FOR THE ADOPTION OF NEW AUTOMOBILITY SOLUTIONS

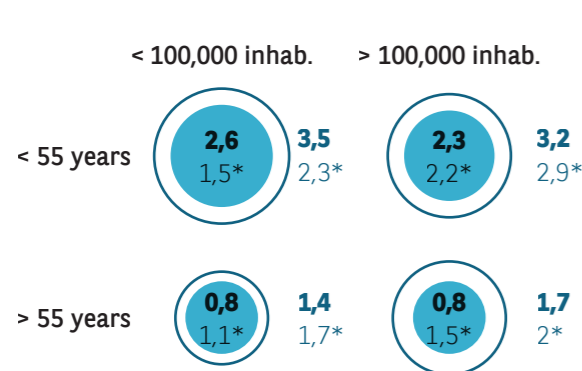

* World average

OVERVIEW

A relatively small proportion of South Africans have a car, but they use them regularly and in a modern way, because the use of both ride sharing and don't do so car sharing is widespread. Surprisingly, contrary to most of the other countries covered, new automobility solutions are more likely to be embraced in sparsely populated areas than in cities.



Germany

The Germans and their cars

CAR USE IN GERMANY

Despite being an emblematic part of the automotive industry, Germany is expected to see a fall in the number of cars on its roads over the coming years. Indeed, the motorization rate of households is now close to saturation point and has barely increased in recent times. Meanwhile, the population is set to decline, which should exacerbate the decrease in the number of cars in circulation. And although the automotive market has recovered somewhat in the last few months, it is still some way below its historical peak (approximately 4 million units). However, as long as there are motorists left in Germany, they will remain fiercely attached to their cars!

- **Market forecast** (New passenger vehicles in millions): **2018: 3,44 | 2019: 3,53 | 2020: 3,45**
- **2018 motorization rate:** **605 vehicles** per 1,000 inhabitants (world: 515)
- **82% are attached to their car (world: 80%)**
- **44% state that they are prepared to not/no longer own a car** (world: 58%), broken down as follows:

	€		
Inhabitants	Income	Gender	Age
< 100,000 38%	Low 54%	Men 44%	< 55 years 46%
> 100,000 54%	High 38%	Women 45%	> 55 years 41%

THE GERMANS AND NEW AUTOMOBILITY SOLUTIONS

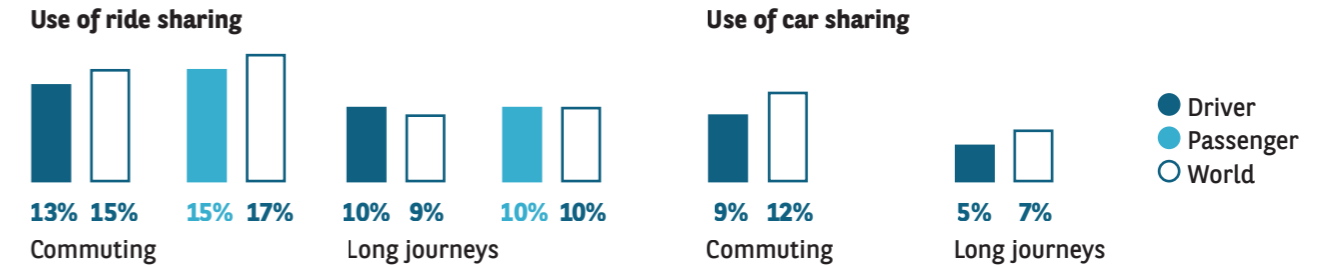

CETELEM INDICATOR FOR THE ADOPTION OF NEW AUTOMOBILITY SOLUTIONS

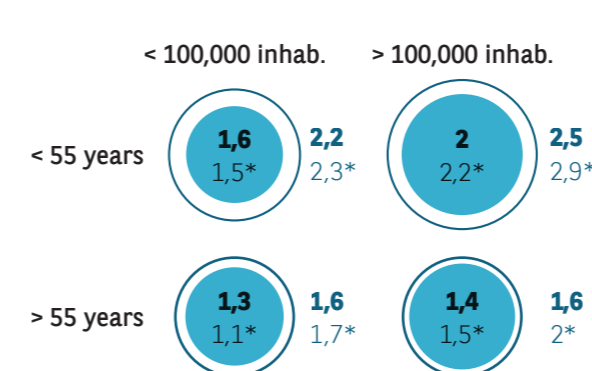

* World average

OVERVIEW

The Germans are only moderately keen on ride sharing and car sharing, and their use of these services is in line with the global average. In addition, German indicators of new automobility solutions remain low and below the global average. These scores do not vary much according to density, given that German cities are not very densely populated.





Belgium

The Belgians and their cars

CAR USE IN BELGIUM

With nearly 600 vehicles per 1,000 inhabitants, Belgium is in line with the average for Western Europe in terms of its motorization rate. Only a small percentage of Belgian respondents can imagine life without owning a car, but their attachment to their vehicle is considerably weaker than the global average. The market, which has traditionally been very much driven by sales to companies, has shrunk this year after the historic peak attained in 2018. A fresh adjustment could occur in 2020.

- **Market forecast** (New passenger vehicles in millions): **2018: 0,6 | 2019: 0,59 | 2020: 0,57**
- **2018 motorization rate: 587 vehicles** per 1,000 inhabitants (world: 515)
- **70% are attached to their car (world: 80%)**
- **46% state that they are prepared** to not/no longer own a car (world: 58%), broken down as follows:

 Inhabitants	 Income	 Gender	 Age
< 100,000 43%	Low 51%	Men 48%	< 55 years 46%
> 100,000 61%	High 39%	Women 44%	> 55 years 48%

THE BELGIANS AND NEW AUTOMOBILITY SOLUTIONS

Use of ride sharing

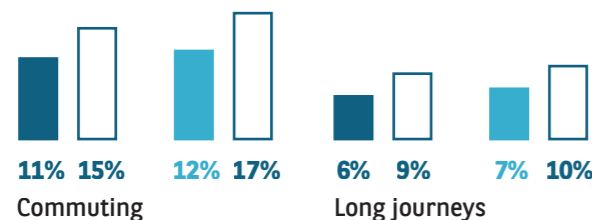

Use of car sharing

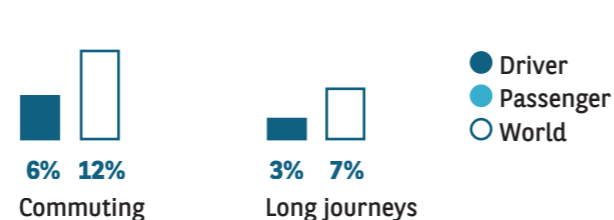

CETELEM INDICATOR FOR THE ADOPTION OF NEW AUTOMOBILITY SOLUTIONS

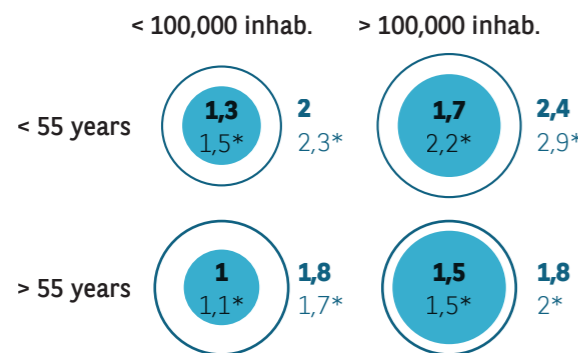

* World average

OVERVIEW

Like their German neighbours, the Belgians post figures below the global average when it comes to the use of ride sharing and indicator, but including car sharing. The size of the country and the density of its public transport network probably have something to do with this. And yet, the indicators relating to new automotive practices are lower than elsewhere in the world.





Brazil

The Brazilians and their cars

CAR USE IN BRAZIL

Brazil still displays great market development potential. The population's average motorization rate is three times lower than Europe's and four times lower than in the United States. But will this potential be fully realized in the future? People's attachment to their cars barely exceeds the international average and the percentage of people who can imagine living without a car is among the highest in the world. Today, Brazil is slowly recovering from the economic crisis that has long held back its car market. Significant growth will take place in 2019 and probably also in 2020.

- **Market forecast** (New passenger vehicles in millions): **2018: 2,10 | 2019: 2,25 | 2020: 2,40**
- **2018 motorization rate: 206 vehicles** per 1,000 inhabitants (world: 515)
- **81% are attached to their car (world: 80%)**
- **72% state that they are prepared** to not/no longer own a car (world: 58%), broken down as follows:

 Inhabitants	 Income	 Gender	 Age
< 100,000 71%	Low 75%	Men 71%	< 55 years 74%
> 100,000 72%	High 68%	Women 72%	> 55 years 64%

THE BRAZILIANS AND NEW AUTOMOBILITY SOLUTIONS

Use of ride sharing

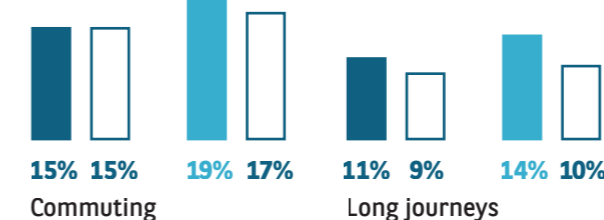

Use of car sharing

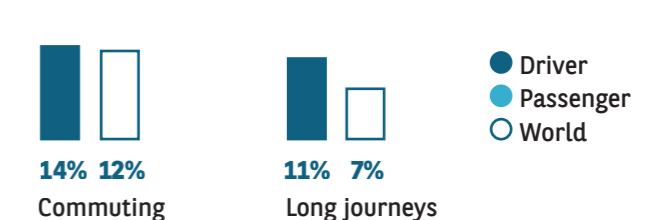

CETELEM INDICATOR FOR THE ADOPTION OF NEW AUTOMOBILITY SOLUTIONS

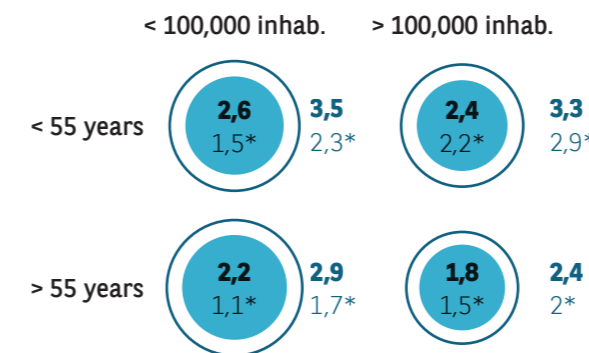

* World average

OVERVIEW

With car ownership still relatively uncommon in their country, Brazilians are slightly more inclined than the global average to engage in ride sharing and car sharing. Their scores for new automobility solutions are relatively high, whether we are talking about the young or older age groups. Like in South Africa, this keenness to embrace new automobility solutions is not confined to big cities.

China

The Chinese and their cars

CAR USE IN CHINA

Car sharing and ride sharing are very well developed in China. Short-distance ride sharing allows city dwellers in particular to avoid parking constraints. Indeed, car parks are rare in China's major cities. Our indicators relating to new automobility solutions are therefore particularly high in China, and not only for young people.

- **Market forecast** (New passenger vehicles in millions): **2018:** 23,71 | **2019:** 21,34 | **2020:** 22,00
- **2018 motorization rate:** **118 vehicles** per 1,000 inhabitants (world: 515)
- **72% are attached to their car (world: 80%)**
- **79% state that they are prepared** to not/no longer own a car (world: 58%), broken down as follows:

Inhabitants	Income	Gender	Age
< 100,000 82%	Low 68%	Men 78%	< 55 years 78%
> 100,000 78%	High 79%	Women 80%	> 55 years 83%

THE CHINESE AND NEW AUTOMOBILITY SOLUTIONS

Use of ride sharing

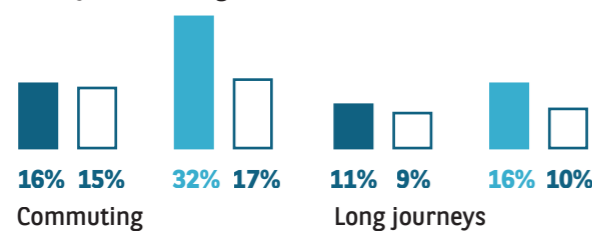

Use of car sharing

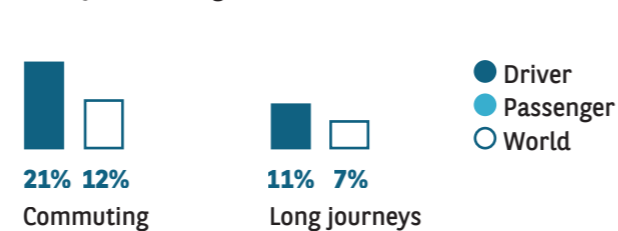

CETEM INDICATOR FOR THE ADOPTION OF NEW AUTOMOBILITY SOLUTIONS

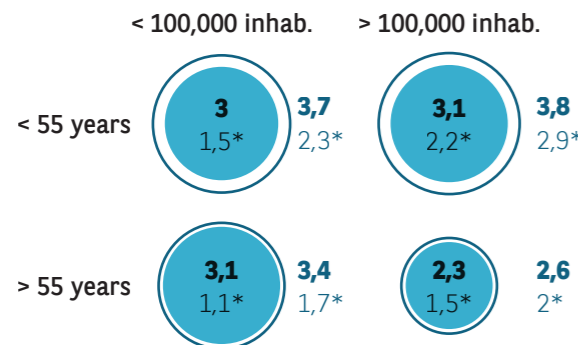

* World average

OVERVIEW

The world's largest market has seen a decline in sales over the last few months. This is the sector's first downturn since it truly took off in the early 2000s. The economic slowdown and the quotas set by explain the decline. And yet, the market's potential remains immense, given the country's demographics and motorization rate, which remains low. Although many Chinese people can imagine life without a car, the government's lifting of sales quotas and the inroads made by cheaper local brands will help the market take off once again.

Spain

The Spaniards and their cars

CAR USE IN SPAIN

The use of ride sharing and car sharing services in Spain is close to the international average, as are its indicators for all new automobility solutions. It is worth noting that these new models are slightly more likely to be embraced by the young and those in the most sparsely populated areas.

- **Market forecast** (New passenger vehicles in millions): **2018:** 1,32 | **2019:** 1,23 | **2020:** 1,20
- **2018 motorization rate:** **616 vehicles** per 1,000 inhabitants (world: 515)
- **89% are attached to their car (world: 80%)**
- **71% state that they are prepared** to not/no longer own a car (world: 58%), broken down as follows:

Inhabitants	Income	Gender	Age
< 100,000 65%	Low 74%	Men 71%	< 55 years 70%
> 100,000 76%	High 64%	Women 71%	> 55 years 71%

THE SPANIARDS AND NEW AUTOMOBILITY SOLUTIONS

Use of ride sharing

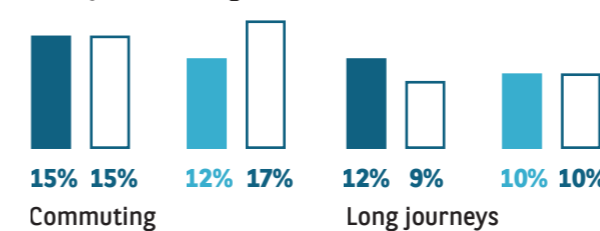

Use of car sharing

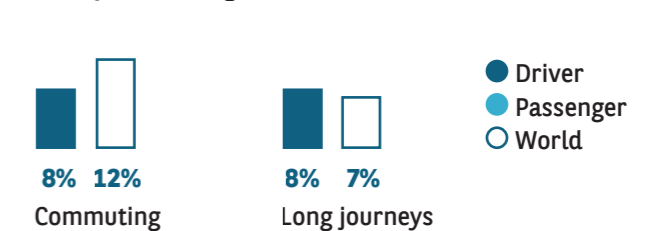

CETEM INDICATOR FOR THE ADOPTION OF NEW AUTOMOBILITY SOLUTIONS

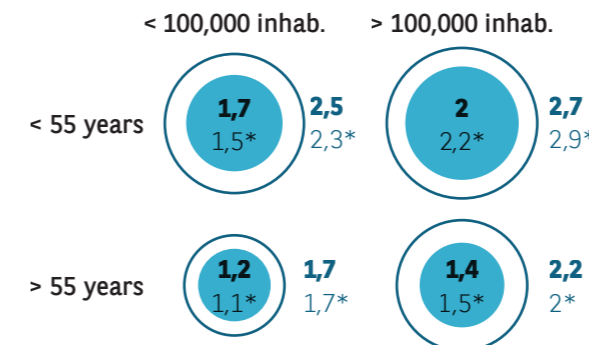

* World average

OVERVIEW

Spaniards are very attached to their cars and they are also among the most reluctant in the world to give them up. This applies to the young and old, and to men and women alike. The motorization rate now exceeds the European average and, given the country's sluggish demographics, there is little hope that the number of cars on the road will grow, with the market essentially being driven by vehicle replacement. However, the sector has recovered well since its complete collapse subsequent to the 2009 crisis. It is set to stabilise and then contract over 2019 and 2020.





United States

The Americans and their cars

CAR USE IN THE UNITED STATES

The spiritual home of the automobile is far from hostile to new ways of accessing motoring. After all, this is the country that invented ride hailing and car sharing. Yet, while the over-55s produce indicators for new automobility solutions that are in line with the global average, the young are still some way behind. But if the "future" indicator is to be believed, this gap will soon be closed.

- **Market forecast** (New passenger vehicles in millions): **2018:** 17,34 | **2019:** 17,08 | **2020:** 16,70
- **2018 motorization rate:** **821 vehicles** per 1,000 inhabitants (world: 515)
- **75% are attached to their car (world: 80%)**
- **51% state that they are prepared** to not/no longer own a car (world: 58%), broken down as follows:

			
Inhabitants	Income	Gender	Age
< 100,000 48%	Low 57%	Men 56%	< 55 years 58%
> 100,000 57%	High 58%	Women 47%	> 55 years 39%

THE AMERICANS AND NEW AUTOMOBILITY SOLUTIONS

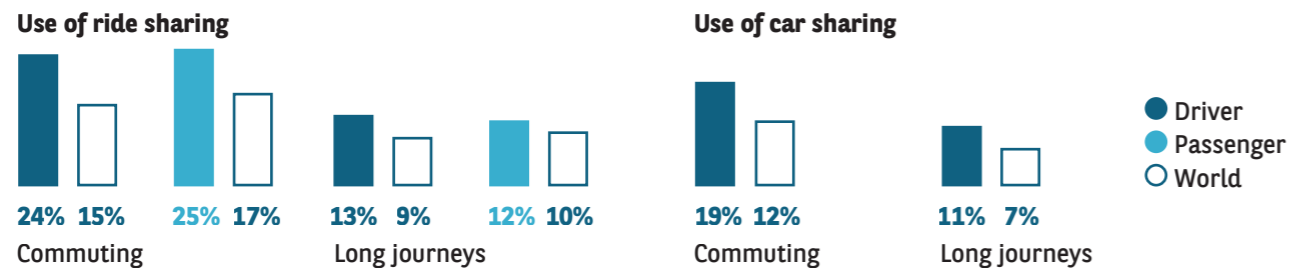

CETELEM INDICATOR FOR THE ADOPTION OF NEW AUTOMOBILITY SOLUTIONS

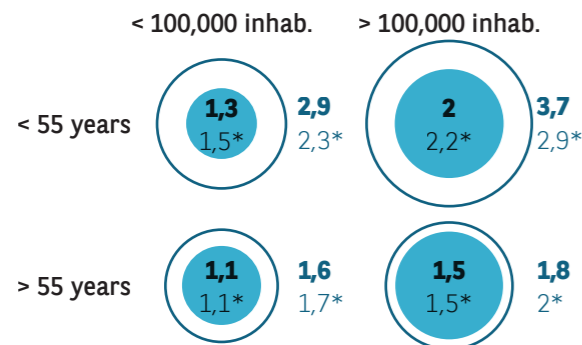

* World average

OVERVIEW

The United States boasts the world's highest motorization rate with 821 light vehicles per 1,000 inhabitants. But although car ownership is extremely widespread and Americans use their cars intensively, they are not as attached to their cars as motorists in certain other countries. On the other hand, rare are those who can imagine life without a car. Sales, which reached a record high in 2018, have held up well in the face of an economic downturn. Any decline observed in 2019 will only be modest, as will probably also be the case in 2020.





France

The French and their cars

CAR USE IN FRANCE

France has a mature automotive market, a high motorization rate and, over the last few years, a growing number of cars on the road. The French tend to be attached to their cars and it is only in the larger cities that people are moving away from car ownership. Indeed, inhabitants of these major urban centres are the most likely to state that they can live without a car. Women and young people are slightly less inclined to give up their wheels.

- **Market forecast** (New passenger vehicles in millions): **2018:** 2,17 | **2019:** 2,17 | **2020:** 2,1
- **2018 motorization rate:** **590 vehicles** per 1,000 inhabitants (world: 515)
- **81% are attached to their car (world: 80%)**
- **43% state that they are prepared** to not/no longer own a car (world: 58%), broken down as follows:

			
Inhabitants	Income	Gender	Age
< 100,000 38%	Low 47%	Men 45%	< 55 years 46%
> 100,000 61%	High 48%	Women 42%	> 55 years 38%

THE FRENCH AND NEW AUTOMOBILITY SOLUTIONS

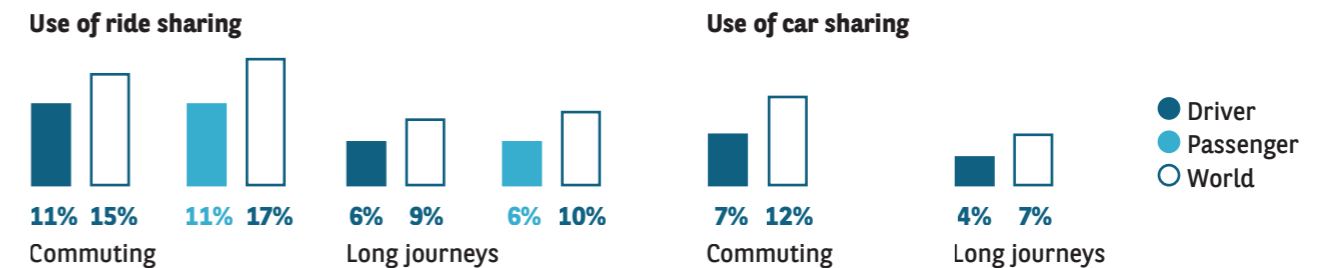

CETELEM INDICATOR FOR THE ADOPTION OF NEW AUTOMOBILITY SOLUTIONS

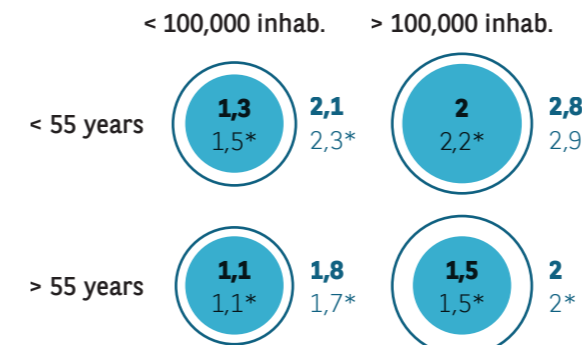

* World average

OVERVIEW

Older French respondents are in line with the international average when it comes to the use of new automobility solutions. Although the young have embraced them more readily than their elders, their results are slightly below the global average. The "adoption potential" indicator suggests that this gap will eventually close in areas with higher population densities.



The Italians and their cars

CAR USE IN ITALY

Enjoying exclusive ownership and use of a vehicle appears to be the preference in Italy. The use of ride sharing and car sharing is below the global average. Nonetheless, while the current indicator for new automobility solutions is below the international average, the future indicator – which reflects potential – suggests that there may be an upturn in these practices over the coming years.

- **Market forecast** (New passenger vehicles in millions): **2018:** 1,91 | **2019:** 1,87 | **2020:** 1,83
- **2018 motorization rate:** **721 vehicles** per 1,000 inhabitants (world: 515)
- **91% are attached to their car (world: 80%)**
- **58% state that they are prepared** to not/no longer own a car (world: 58%), broken down as follows:

	€		
Inhabitants	Income	Gender	Age
< 100,000 57%	Low 61%	Men 60%	< 55 years 61%
> 100,000 60%	High 59%	Women 56%	> 55 years 54%

THE ITALIANS AND NEW AUTOMOBILITY SOLUTIONS

Use of ride sharing

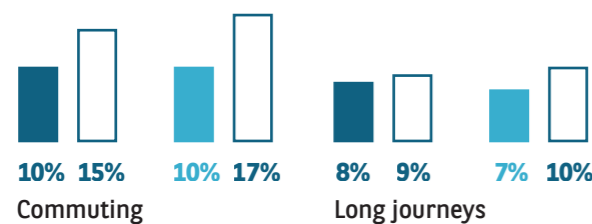

Use of car sharing

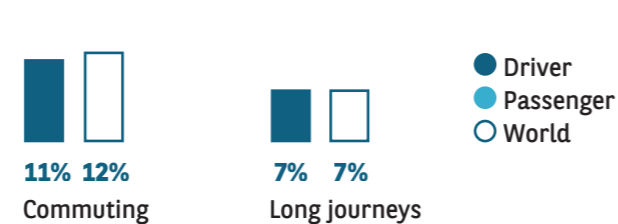

CETELEM INDICATOR FOR THE ADOPTION OF NEW AUTOMOBILITY SOLUTIONS

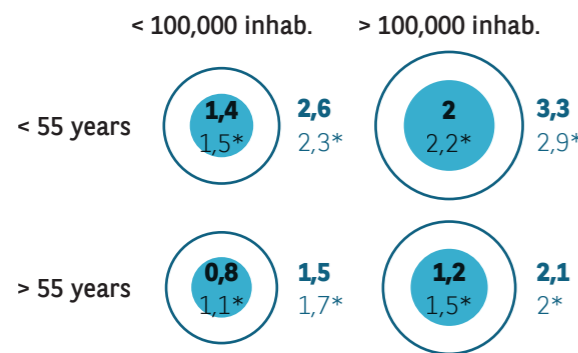

* World average

● **Current adoption:** Frequency of car sharing, ride sharing and ride hailing journeys, subscription to ride sharing and car sharing services, adoption practices to reduce vehicle costs, taking into account "I do so already and intend to continue" answers.

○ **Adoption potential:** Same variables as the "current adoption" indicator, but including "I don't do so yet, but I would like to" answers.

OVERVIEW

Italy has the highest motorization rate in Europe – the figure is between the European average and the level observed in the United States – so it makes sense that Italians are the most attached to their cars. However, they sit somewhere close to the global average when it comes to imagining themselves living without a car. With a motorization rate that is reaching saturation point and a declining population, the number of cars on the road in Italy is very unlikely to grow. Like in Spain, where the market fell sharply after the 2009 financial crisis, the sector has recovered in recent years. And also like in Spain, it will contract in 2019 and 2020.



The Japanese and their cars

CAR USE IN JAPAN

Keener on ride sharing than car sharing, the Japanese are not averse to the idea of using a car they don't own. Their indicators for new automobility solutions are currently very close to the global average. Their future development potential also seems to indicate that they will eventually adopt these new practices to a similar degree to the rest of the world.

- **Market forecast** (New passenger vehicles in millions): **2018:** 4,39 | **2019:** 4,48 | **2020:** 4,48
- **2018 motorization rate:** **609 vehicles** per 1,000 inhabitants (world: 515)
- **84% are attached to their car (world: 80%)**
- **61% state that they are prepared** to not/no longer own a car (world: 58%), broken down as follows:

	€		
Inhabitants	Income	Gender	Age
< 100,000 57%	Low 64%	Men 55%	< 55 years 59%
> 100,000 62%	High 54%	Women 66%	> 55 years 63%

THE JAPANESE AND NEW AUTOMOBILITY SOLUTIONS

Use of ride sharing

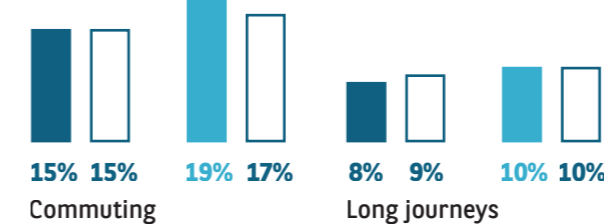

Use of car sharing

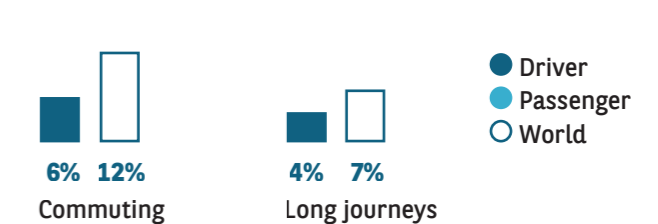

CETELEM INDICATOR FOR THE ADOPTION OF NEW AUTOMOBILITY SOLUTIONS

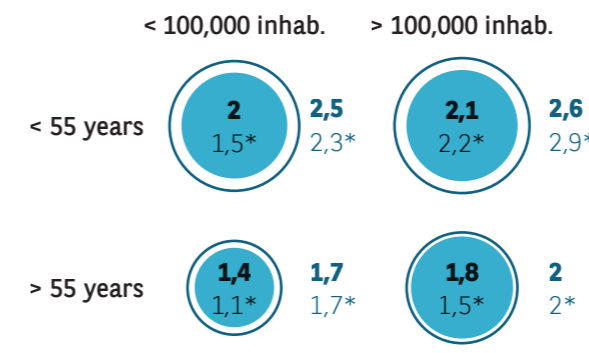

* World average

● **Current adoption:** Frequency of car sharing, ride sharing and ride hailing journeys, subscription to ride sharing and car sharing services, adoption practices to reduce vehicle costs, taking into account "I do so already and intend to continue" answers.

○ **Adoption potential:** Same variables as the "current adoption" indicator, but including "I don't do so yet, but I would like to" answers.

OVERVIEW

While they are more attached to their car than the global average, car ownership in Japan is close to the mean figure. However, relatively few of them can imagine life without a car, especially women and older respondents. With an economy that is not particularly vibrant and a population that has been falling for almost two decades, the Japanese automobile market is now contracting. Various stimulus measures have allowed the market to stabilize in 2019, but significant future sales growth in the country is very unlikely.





Netherlands

The Dutch and their cars

CAR USE IN THE NETHERLANDS

When they are not in their cars, the Dutch are either on a bicycle or in someone else's vehicle. Their use of ride sharing and car sharing is comparable to that of other countries in the survey. Equally, their indicators for new automobility practices are similar to those elsewhere in the world and, like in the other countries, young people in the Netherlands are more willing to share a car.

- **Market forecast** (New passenger vehicles in millions): **2018: 0,44 | 2019: 0,41 | 2020: 0,40**
- **2018 motorization rate:** **557 vehicles** per 1,000 inhabitants (world: 515)
- **80% are attached to their car (world: 80%)**
- **52% state that they are prepared** to not/no longer own a car (world: 58%), broken down as follows:

			
Inhabitants	Income	Gender	Age
< 100,000 49%	Low 58%	Men 52%	< 55 years 54%
> 100,000 61%	High 61%	Women 53%	> 55 years 49%

THE DUTCH AND NEW AUTOMOBILITY SOLUTIONS

Use of ride sharing

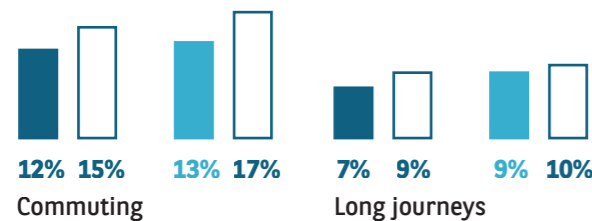

Use of car sharing

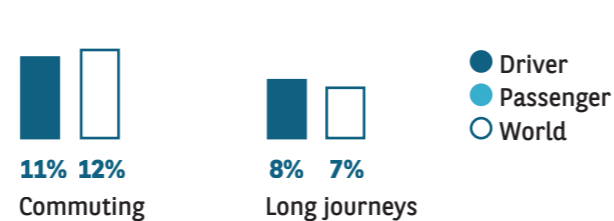

CETELEM INDICATOR FOR THE ADOPTION OF NEW AUTOMOBILITY SOLUTIONS

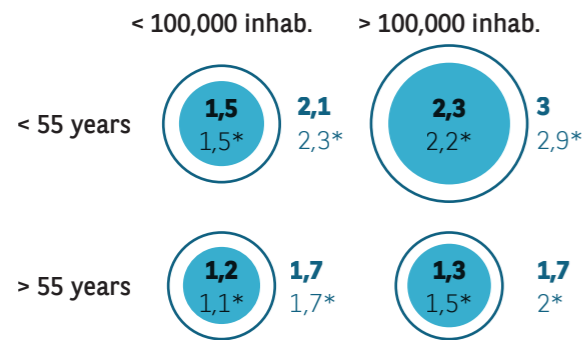

* World average

● **Current adoption:** Frequency of car sharing, ride sharing and ride hailing journeys, subscription to ride sharing and car sharing services, adoption practices to reduce vehicle costs, taking into account "I do so already and intend to continue" answers.

○ **Adoption potential:** Same variables as the "current adoption" indicator, but including "I don't do so yet, but I would like to" answers.

OVERVIEW

Being densely populated, highly urbanized and small in size, the Netherlands does not have one of the highest motorization rates in the world. However, Dutch people's attachment to their cars is on a par with the rest of the world. They find it slightly harder than average to imagine life without a car, although the opposite is true for young people. Overall, the results are fairly homogeneous across income categories and genders. New-car sales have been rather buoyant in recent years, but a drop in the number of registrations has been observed in 2019 and is set to continue in 2020.





Poland

The Poles and their cars

CAR USE IN POLAND

The Poles are slightly less likely to use car sharing and ride sharing than inhabitants of other countries in the L'Observatoire survey. Indeed, their scores when it comes to new automobility solutions are slightly lower than the global average in more populous areas and higher in less densely populated zones. And according to the indicators reflecting the potential of new automobility solutions, the situation looks unlikely to change.

- **Market forecast** (New passenger vehicles in millions): **2018: 0,53 | 2019: 0,54 | 2020: 0,53**
- **2018 motorization rate:** **698 vehicles** per 1,000 inhabitants (world: 515)
- **91% are attached to their car (world: 80%)**
- **53% state that they are prepared** to not/no longer own a car (world: 58%), broken down as follows:

			
Inhabitants	Income	Gender	Age
< 100,000 48%	Low 52%	Men 56%	< 55 years 51%
> 100,000 60%	High 54%	Women 49%	> 55 years 56%

THE POLES AND NEW AUTOMOBILITY SOLUTIONS

Use of ride sharing

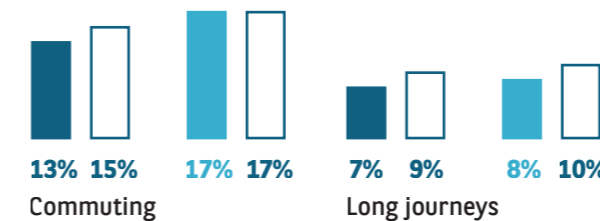

Use of car sharing

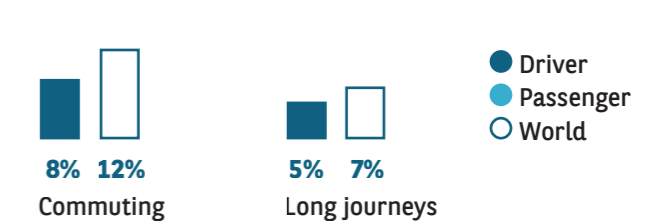

CETELEM INDICATOR FOR THE ADOPTION OF NEW AUTOMOBILITY SOLUTIONS

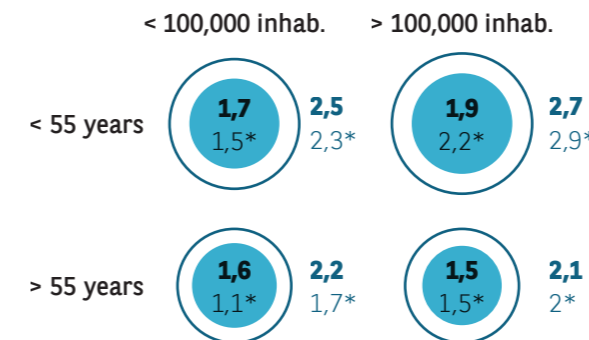

* World average

● **Current adoption:** Frequency of car sharing, ride sharing and ride hailing journeys, subscription to ride sharing and car sharing services, adoption practices to reduce vehicle costs, taking into account "I do so already and intend to continue" answers.

○ **Adoption potential:** Same variables as the "current adoption" indicator, but including "I don't do so yet, but I would like to" answers.

OVERVIEW

The Poles stand out for their very high level of attachment to their cars. Their motorization rate, which is among the highest in Europe, is clear evidence of this. Similarly, relatively few of them can stomach the idea of living without a car, especially rural dwellers, young people and women. Already strong in 2018, sales have continued to rise in 2019. However, a drop in the number of registrations is expected in 2020.

Portugal

The Portuguese and their cars

CAR USE IN PORTUGAL

Whether it be ride sharing or car sharing, the Portuguese rarely travel in a car that does not belong to them.

In addition, Portuguese indicators for new automobility solutions are among the lowest in the world and the growth potential they display is not significant. Moreover, respondents young and old post the same scores.

• **Market forecast** (New passenger vehicles in millions):
2018: 0,23 | 2019: 0,22 | 2020: 0,21

• **2018 motorization rate:**
611 vehicles per 1,000 inhabitants (world: 515)

• **75% are attached to their car (world: 80%)**

• **53% state that they are prepared** to not/no longer own a car (world: 58%), broken down as follows:

Inhabitants	Income	Gender	Age
< 100,000 49%	Low 55%	Men 54%	< 55 years 50%
> 100,000 60%	High 50%	Women 52%	> 55 years 56%

THE PORTUGUESE AND NEW AUTOMOBILITY SOLUTIONS

Use of ride sharing

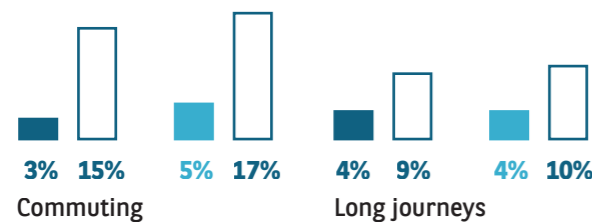

Use of car sharing

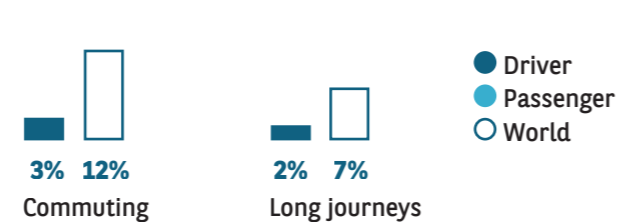

CETELEM INDICATOR FOR THE ADOPTION OF NEW AUTOMOBILITY SOLUTIONS

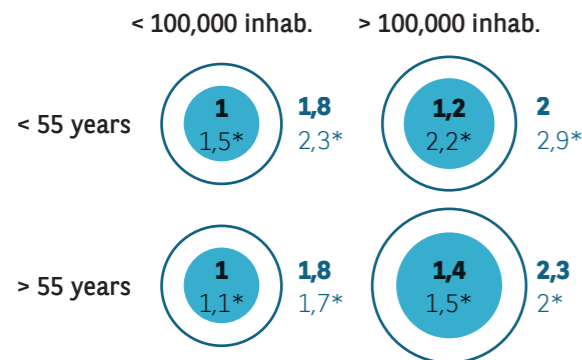

* World average

OVERVIEW

While below the levels attained by the Italians and Poles, the Portuguese post a rather high motorization rate compared with other European countries. Although they are less attached to their cars than actually see themselves living without a car. The figure is even lower for young people and those who live in rural areas. The Portuguese automobile market is not particularly buoyant at the moment. Sales are expected to fall in both 2019 and 2020.

United Kingdom

The British and their cars

CAR USE IN THE UNITED KINGDOM

The British have embraced ride sharing and car sharing, particularly over short distances.

Whether we are talking about the current situation or how it will develop in the future, the younger generations post much higher indicators for the use of new forms of automobility (above the global average) than their elders (below average).

• **Market forecast** (New passenger vehicles in millions):
2018: 2,4 | 2019: 2,3 | 2020: 2,2

• **2018 motorization rate:**
617 vehicles per 1,000 inhabitants (world: 515)

• **75% are attached to their car (world: 80%)**

• **66% state that they are prepared** to not/no longer own a car (world: 58%), broken down as follows:

Inhabitants	Income	Gender	Age
< 100,000 64%	Low 71%	Men 68%	< 55 years 65%
> 100,000 71%	High 65%	Women 65%	> 55 years 68%

THE BRITISH AND NEW AUTOMOBILITY SOLUTIONS

Use of ride sharing

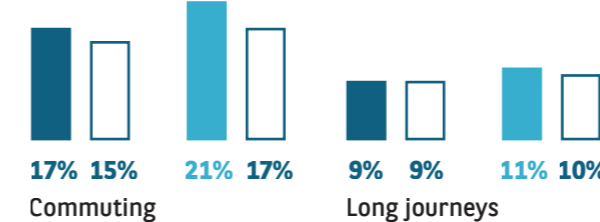

Use of car sharing

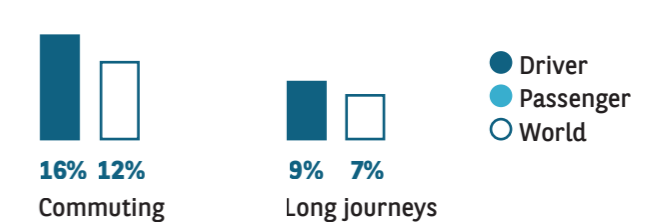

CETELEM INDICATOR FOR THE ADOPTION OF NEW AUTOMOBILITY SOLUTIONS

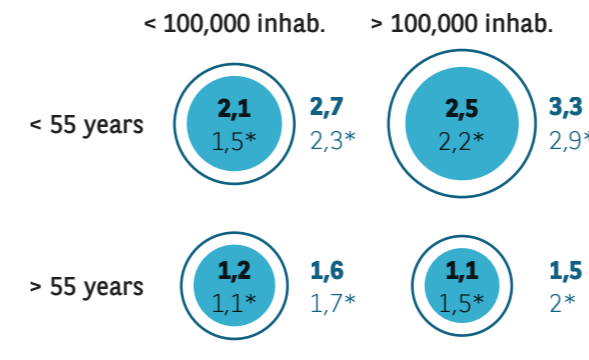

* World average

OVERVIEW

While their motorization rate is slightly above the European average, the British are no more attached to their cars than their European neighbours. In fact, two-thirds can imagine life without a car. This is a particularly strongly held view in the lower income categories. Until now, car sales had done fairly well to withstand the economic slowdown and the uncertainty of Brexit. However, recent figures clearly point to a decline in sales in both 2019 and 2020.

Turkey

The Turks and their cars

CAR USE IN TURKEY

Given their country's low motorization rate, the Turks partake in car sharing in large numbers, and even more so in ride sharing over both long and short distances. Thus, they post high indicators for the use of new automobility solutions. As often, these are particularly high among the young. They are also higher in sparsely populated areas, which is something of a rarity.

• **Market forecast** (New passenger vehicles in millions):
2018: 0,49 | 2019: 0,32 | 2020: 0,32

• **2018 motorization rate:**
195 vehicles per 1,000 inhabitants (world: 515)

• **♥ 77% are attached to their car** (world: 80%)

• **61% state that they are prepared to not/no longer own a car** (world: 58%), broken down as follows:

Inhabitants	Income	Gender	Age
< 100,000 60%	Low 69%	Men 58%	< 55 years 59%
> 100,000 61%	High 53%	Women 63%	> 55 years 66%

THE TURKS AND NEW AUTOMOBILITY SOLUTIONS

Use of ride sharing

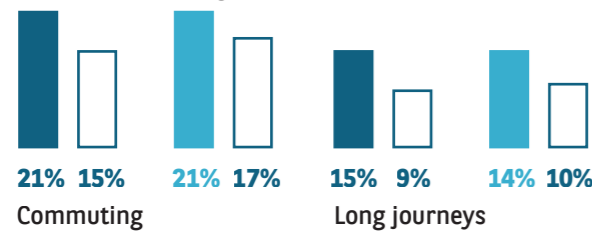

Use of car sharing

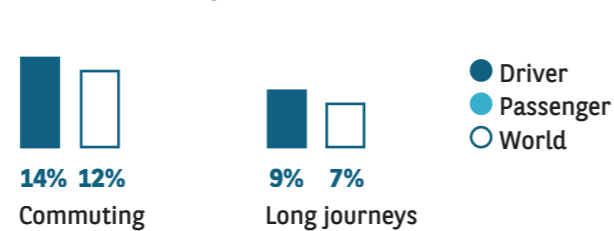

CETELEM INDICATOR FOR THE ADOPTION OF NEW AUTOMOBILITY SOLUTIONS

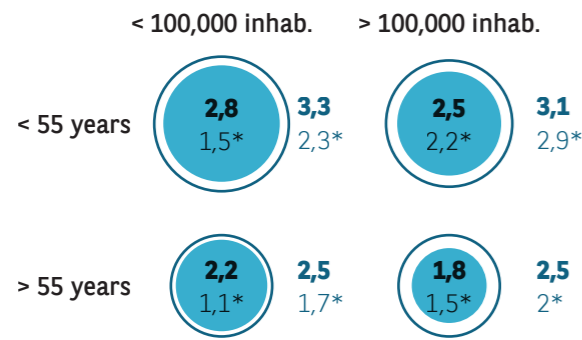

● **Current adoption:** Frequency of car sharing, ride sharing and ride hailing journeys, subscription to ride sharing and car sharing services, adoption practices to reduce vehicle costs, taking into account "I do so already and intend to continue" answers.

○ **Adoption potential:** Same variables as the "current adoption" indicator, but including "I don't do so yet, but I would like to" answers.

OVERVIEW

With fewer than 200 vehicles per 1,000 inhabitants, the potential for increases in the motorization rate and the number of cars on the road in Turkey remains high. People's attachment to their cars is slightly lower than in the rest of the world and the proportion of respondents who state that they can imagine living without a car is higher. This is particularly true for women and older people. The economic gloom hanging over the country is stunting the market's growth and a sharp drop in sales is expected in 2019. This decline is set to continue in 2020.

* World average

L'OBSERVATOIRE CETELEM

Founded in 1985, L'Observatoire Cetelem is an economic research and intelligence unit of the BNP Paribas Personal Finance group, headed by Flavien Neuvy.

In what is a time of deep transformation for retail and consumption models, L'Observatoire Cetelem strives to understand the changes affecting consumption. To fulfil this ambition, L'Observatoire Cetelem has set up a range of tools to observe and analyse the world around us, based on diverse and complementary content:

- **The Observatoires:** Two highly respected international consumer surveys performed in 15 countries on an annual basis, one focusing on the automotive market and the other on consumption in general.
- **L'Œil,** a spotlight on new developments in the retail sphere and on the latest micro-initiatives highlighting innovations and shifts that could shape consumption in the future.
- **Our z00m** studies focus on lifestyles and explore a particular theme (housing, sport, education, culture, the human body, etc.) in three stages, by seeking the opinion of French citizens via a three-wave survey.

www.observatoirecetelem.com | @obs_cetelem

#PROSPECTIVE

Visit the website:

www.observatoirecetelem.com

Keep up with the latest news from L'Observatoire Cetelem on Twitter and Facebook

@obs_cetelem | Observatoire Cetelem

Contact Flavien Neuvy, Head of L'Observatoire Cetelem

flavien.neuvy@cetelem.fr

OBSERVATOIRE
Cetelem

